



CAST STONE WALL™ TECHNICAL INSTALLATION GUIDE



EP HENRY®



Single Sided Cast Stone Wall and Cast Stone Wall Face Shells Aspen



Single Sided Cast Stone Wall and Cast Stone Wall Fire Pit Kit Breckenridge



Double Sided Cast Stone Wall and Cast Stone Wall Face Shells Adirondack



Double Sided Cast Stone Wall Aspen. 36" Isokern Fireplace with Cast Stone Wall Face Shells Aspen



Cast Stone Wall Face Shells Breckenridge



Double Sided Cast Stone Wall Birch

CAST STONE WALL™ TECHNICAL INSTALLATION GUIDE

Single Sided Cast Stone Wall

Product Details	2
Installation Guide	3
Typical Unit Detail	4
Base Leveling Pad Isometric	5
Typical Gravity Wall Section	6
Typical Reinforced Wall Section	7
Corner Detail	8
Top of Wall Steps Detail	9
27° Soil Friction Angle Grid Chart	10
30° Soil Friction Angle Grid Chart	11
32° Soil Friction Angle Grid Chart	12

Double Sided Cast Stone Wall

Product Details	13
Installation Guide	14
Typical Unit Detail	16
Base Course Construction Detail	17
Freestanding Wall Section	18
End Wall Construction Detail	19
Column Corner Construction Detail	20
Column Corner Single Wall Construction Detail	21
Wall Radius Detail	22

Special Applications

Seating Wall Construction Detail	23
Typical Step Installation Detail	24
Column Detail	25
Seating Wall Section	26

Cast Stone Wall Fire Pit Kit

Installation Detail	28
Cross-Section	29

Cast Stone Wall Face Shells

Cast Stone Wall FAQs	31
----------------------	----



Cast Stone Wall and Cast Stone Wall Face Shells, Adirondack

SINGLE SIDED CAST STONE WALL™



Single Sided Cast Stone Wall Aspen with Devonstone® Caps and Stair Treads Bluestone



Adirondack, Full Face



Aspen, Random Face



Birch, Random Face



Breckenridge, Mixed Face

All units are 6" high.



	STRETCHER	CORNER	STRETCHER—REDUCED QTY PALLET
SIZE (LxD)	16" x 12"	16" x 8"	16" x 12"
SF PER CUBE	40	16	24
PCS PER CUBE	60	24	36
LBS PER PIECE	50	34	50
LBS PER CUBE	3,000	850	1800

NOTE

Single Sided Cast Stone Wall comes in 2 cube configurations: Full Face which contains all straight 6x16 faces and Random Face which contains a mix of random joint faces. Full and Random Face units can be combined in a wall.

- Each Cast Stone Wall unit is .67 square face feet
- Maximum reinforced wall height is 8 feet under ideal conditions

SINGLE SIDED CAST STONE WALL INSTALLATION GUIDE

CALCULATE MATERIALS NEEDED

Refer to the Single Sided Cast Stone Wall Calculator.

PREPARE THE FOOTING

Dig a trench 24" wide and a minimum of 12" below grade. Make sure the soil at the bottom of the trench is well compacted to prevent settling. In heavy or clay soils for best results, wrap the footer trench in a "U" shape configuration with geotextile. This will preserve the stone base over time and keep it from migrating into the clay soil. Using a vibratory plate compactor install 6" of modified stone in two 3" layers making sure the surface of the last layer is smooth and level. Tip: Add a uniform 1" layer of sand or stone screenings on top of the footing to make the base course easier to level.

INSTALL THE BASE COURSE USING TERRACE WALL™

Install Terrace Wall as the base course by placing the units, lip side up, on the prepared base.

Level the Terrace Wall base course units from front to back and side-to-side using a dead blow hammer and level. Use a string line along the back of the block to verify straightness.

Note: Core fill all units with #57 (1-1/4", 3/4" and 1/2") or #67 (3/4") clean stone. Crushed or recycled concrete is NOT suitable for this purpose.

BACKFILL THE UNITS

Backfill at least 12" behind each layer of Cast Stone Wall with #57 (1-1/4", 3/4" and 1/2") or #67 (3/4") clean stone (for drainage) with soil behind the drainage stone. All disturbed areas behind the units must be filled and compacted. Tip: One ton of 3/4" clean stone will core fill and backfill about 21 Cast Stone Wall blocks.

INSTALLING ADDITIONAL COURSES

Place the next and additional courses of Cast Stone Wall in such a fashion that each block bridges two units below in a running bond pattern. Cast Stone Wall is intended to be built as a vertical wall system. Use a level against the back of the blocks to determine vertical alignment from course to course. Use a high strength, flexible concrete adhesive to bond every course to the one below including the Terrace Wall base course. EP Henry recommends the use of Techniseal Structure Bond Adhesive. Backfill each course as the wall is being built and fill the block cores with #57 (1-1/4", 3/4" and 1/2") or #67 (3/4") clean stone.

CAP THE WALL

Cut caps with a diamond blade saw to fit, as needed. Attach the wall cap block with a high strength, flexible concrete adhesive.

ADDITIONAL TIPS: BUILDING 90° CORNERS

Full Face and Random Face 8"x6"x16" units with a finished end are available for 90° corners.

CONSTRUCTING CURVED OR SERPENTINE WALLS

The tapered shape of Cast Stone Wall makes it easy to create curved walls without any additional work.

CONSTRUCTING STEPS

Attractive steps, in either straight or semi-circular designs, are easy to build with Cast Stone Wall units. The block units are used for the risers, with the block caps or another material, such as Bullnose Pavers, used for the tread. Use the Step Filler block in step applications where the product will not be visible.

NOTE: THESE INSTRUCTIONS ARE MEANT AS A GENERAL GUIDELINE FOR WALLS UNDER IDEAL CONDITIONS, AND ASSUMING NO SLOPES OR SURCHARGES. SITE-SPECIFIC CONDITIONS MAY WARRANT ADDITIONAL INSTALLATION REQUIREMENTS.

SINGLE SIDED CAST STONE WALL CALCULATOR

		WALL LENGTH														
		1'4"	2'8"	4'0"	5'4"	6'8"	8'0"	9'4"	10'8"	12'0"	13'4"	14'8"	16'0"	17'4"	18'8"	20'0"
WALL HEIGHT	6"	1	2	3	4	5	6	7	8	9	10	11	12	13	14	15
	1'0"	2	4	6	8	10	12	14	16	18	20	22	24	26	28	30
	1'6"	3	6	9	12	15	18	21	24	27	30	33	36	39	42	45
	2'0"	4	8	12	16	20	24	28	32	36	40	44	48	52	56	60
	2'6"	5	10	15	20	25	30	35	40	45	50	55	60	65	70	75
	3'0"	6	12	18	24	30	36	42	48	54	60	66	72	78	84	90
CAPS		1	2	3	4	5	6	7	8	9	10	11	12	13	14	15

Maximum unreinforced wall height is 30" (5 courses).
 Stretcher Unit Size: 12"Dx6"Hx16"W Weight: Approx. 50 lbs.
 Corner Unit Size: 8"Dx6"Hx16"W Weight: Approx. 34 lbs.

14" Double Sided Devonstone Cap: 36" x 14" x 2" Weight: 80 lbs.

NOTES:

1. CAST STONE WALL COMES IN A RANDOM MIX OF PROFILES IN 2 CUBE OFFERINGS: CAST STONE WALL FULL FACE IS ALL STRAIGHT. 6X16 FACES AND CAST STONE WALL RANDOM FACE HAS RANDOM JOINT FACES.
2. CORES AND VOIDS SHALL BE FILLED WITH A #57 CLEAN STONE MEETING THE FOLLOWING GRADATION:

<u>SIEVE SIZE:</u>	<u>% PASSING:</u>
1"	100 - 95
1/2"	100 - 25
No.4	0 - 10
No.8	0 - 5

3. ALL BASE UNITS SHALL BE TERRACE WALL STRETCHER UNITS AND SHALL HAVE A MINIMUM EMBEDMENT DEPTH OF 6".
4. HIGH STRENGTH CONCRETE ADHESIVE SHALL BE USED BETWEEN UNITS ON EACH SUCCESSIVE COURSE BEGINNING AT THE TOP OF THE BASE UNITS.

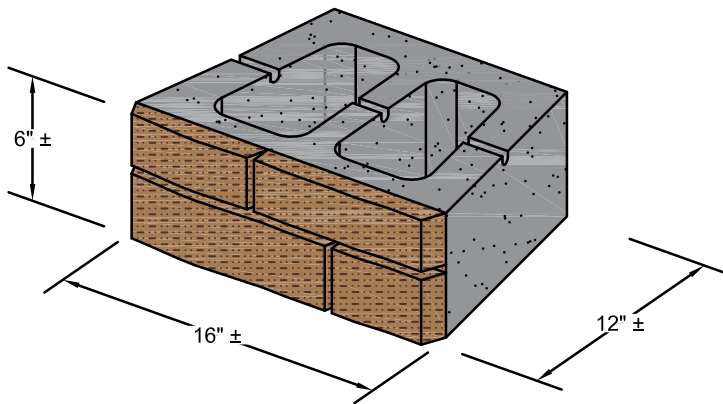

RANDOM FACE STRETCHER

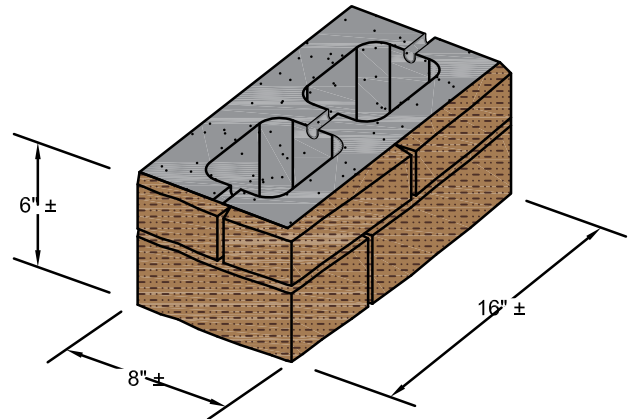

RANDOM FACE CORNER

NOTES:

1. THE LEVELING PAD SHALL BE CONSTRUCTED OF DGA OR CLEAN #57 STONE MEETING THE FOLLOWING GRADATION:

<u>SIEVE SIZE:</u>	<u>% PASSING:</u>
1"	100 - 95
1/2"	100 - 25
No.4	0 - 10
No.8	0 - 5

2. THE BASE FOUNDATION SHALL BE APPROVED BY THE SITE GEOTECHNICAL ENGINEER PRIOR TO PLACEMENT OF THE LEVELING PAD.
3. ALL BASE BLOCKS SHALL BE TERRACE WALL STRETCHER UNITS.

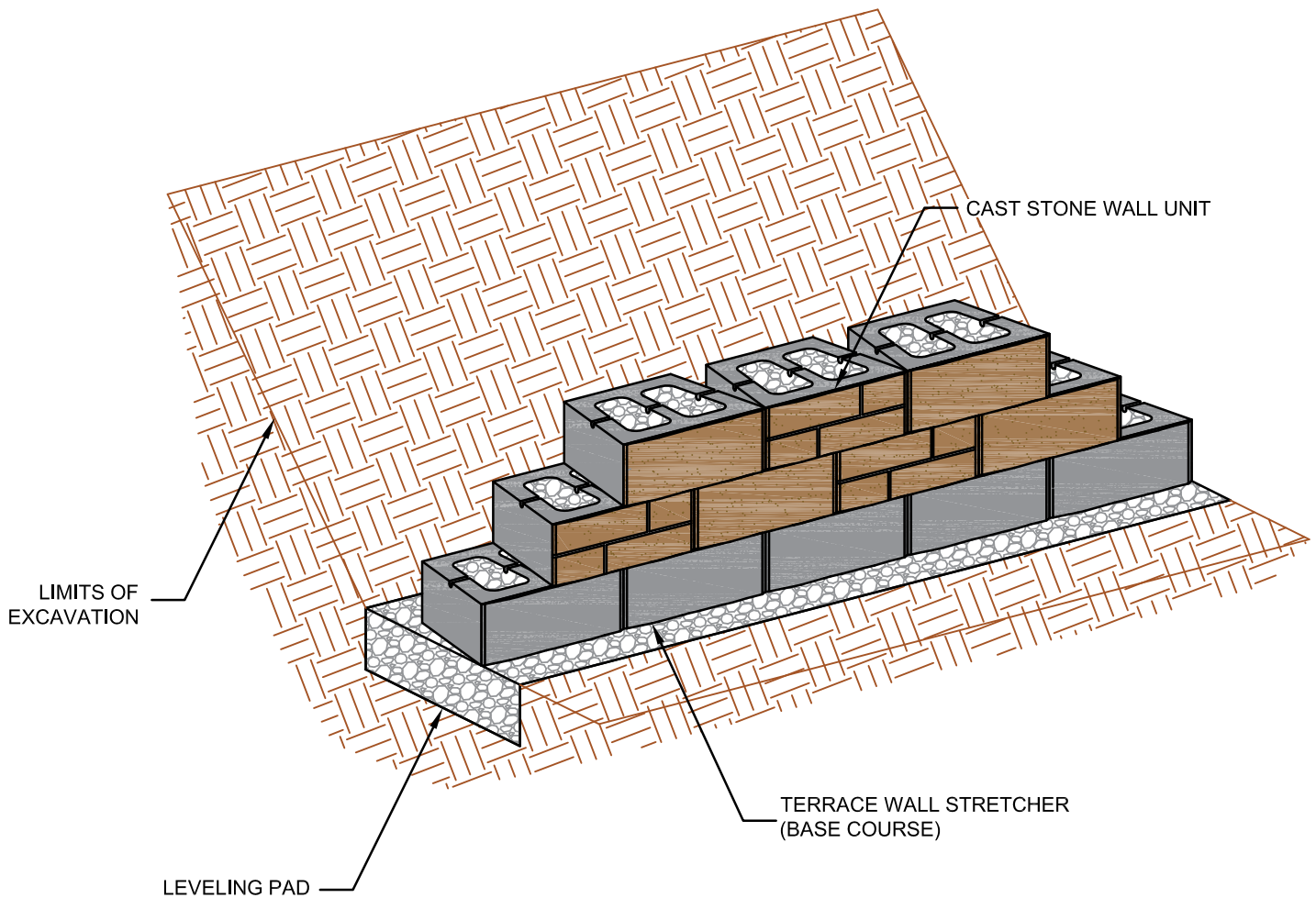

NOTES:

1. FOUNDATION SOILS SHALL BE PREPARED PER THE GEOTECHNICAL ENGINEERS RECOMMENDATIONS PRIOR TO CONSTRUCTION.
2. OUTLET 4" MINIMUM DRAIN PIPE THROUGH THE WALL FACE OR INTO ONSITE DRAINAGE.
3. CAST STONE WALL UNIT COREFILL AND 12" DRAINAGE ZONE SHALL BE FILLED WITH #57 CLEAN STONE MEETING THE FOLLOWING GRADATION:

SIEVE SIZE: % PASSING:

1"	100 - 95
1/2"	100 - 25
No.4	0 - 10
No.8	0 - 5

4. ALL BASE UNITS SHALL BE TERRACE STRETCHER UNITS AND SHALL HAVE A MINIMUM EMBEDMENT DEPTH OF 6".
5. HIGH STRENGTH CONCRETE ADHESIVE SHALL BE USED BETWEEN UNITS ON EACH SUCCESSIVE COURSE BEGINNING AT THE TOP OF THE BASE UNITS.

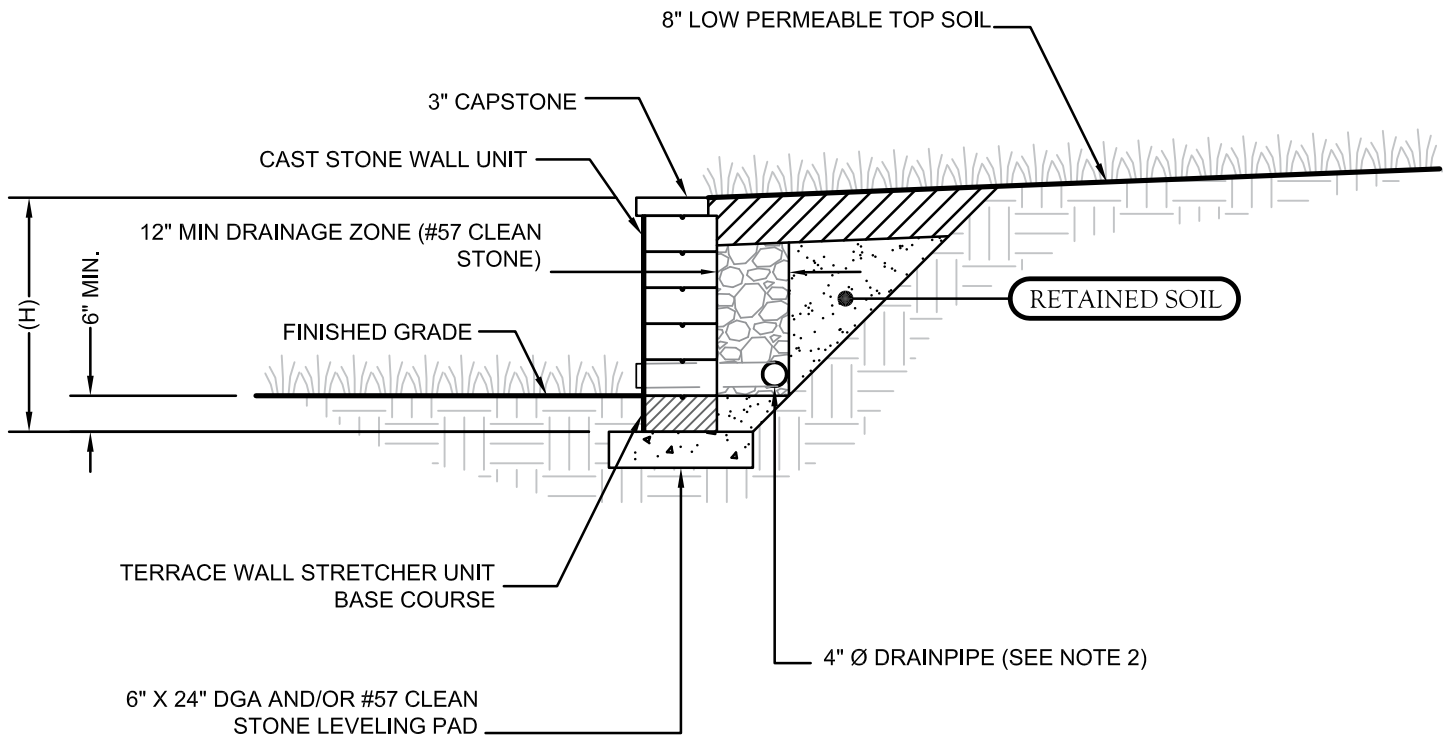

TYPICAL GRAVITY WALL SECTION

NOTES:

1. FOUNDATION SOILS SHALL BE PREPARED PER THE GEOTECHNICAL ENGINEERS RECOMMENDATIONS PRIOR TO CONSTRUCTION.
2. OUTLET 4" MINIMUM DRAIN PIPE THROUGH THE WALL FACE OR INTO ONSITE DRAINAGE.
3. CAST STONE WALL UNIT COREFILL AND 12" DRAINAGE ZONE SHALL BE FILLED WITH #57 CLEAN STONE MEETING THE FOLLOWING GRADATION:

SIEVE SIZE: % PASSING:

1"	100 - 95
1/2"	100 - 25
No.4	0 - 10
No.8	0 - 5

4. ALL BASE UNITS SHALL BE TERRACE STRETCHER UNITS AND SHALL HAVE A MINIMUM EMBEDMENT DEPTH OF 6".
5. HIGH STRENGTH CONCRETE ADHESIVE SHALL BE USED BETWEEN UNITS ON EACH SUCCESSIVE COURSE BEGINNING AT THE TOP OF THE BASE UNITS.
6. CONSULT WITH LOCAL CODE OFFICIAL FOR WALLS GREATER THAN 4 FEET.

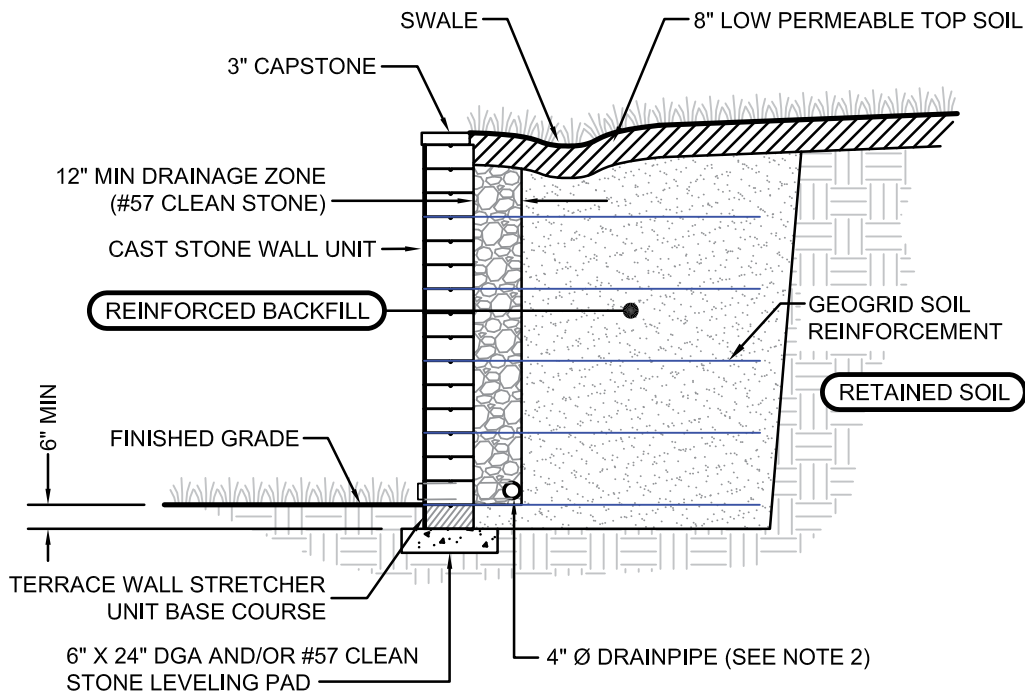

TYPICAL REINFORCED WALL SECTION



201 Park Ave.
Woodbury, NJ 08096
(800)-444-3679
www.ephenry.com

TITLE: CAST STONE WALL
TYPICAL REINFORCED WALL SECTION

SCALE: NOT TO SCALE

24" MIN DRAINAGE ZONE ON CORNER

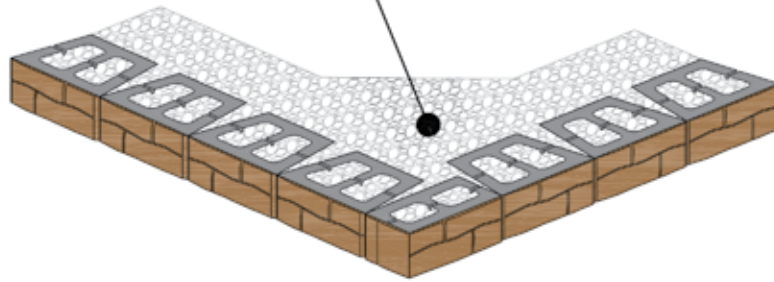

COURSE 1

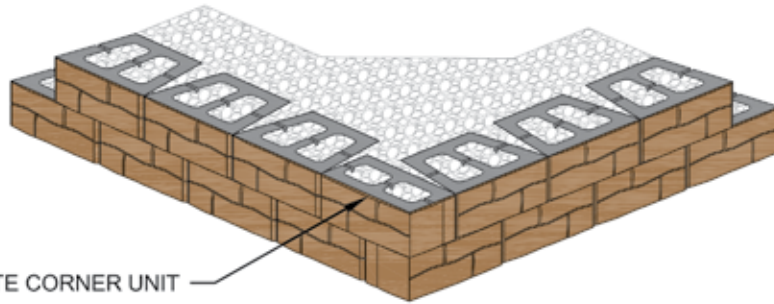

COURSE 2

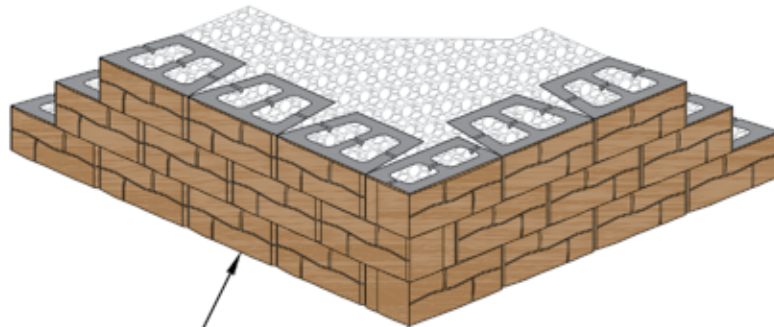

COURSE 3

NOTES:

1. HIGH STRENGTH CONCRETE ADHESIVE SHALL BE USED BETWEEN UNITS ON EACH SUCCESSIVE COURSE BEGINNING AT THE TOP OF THE BASE UNITS.

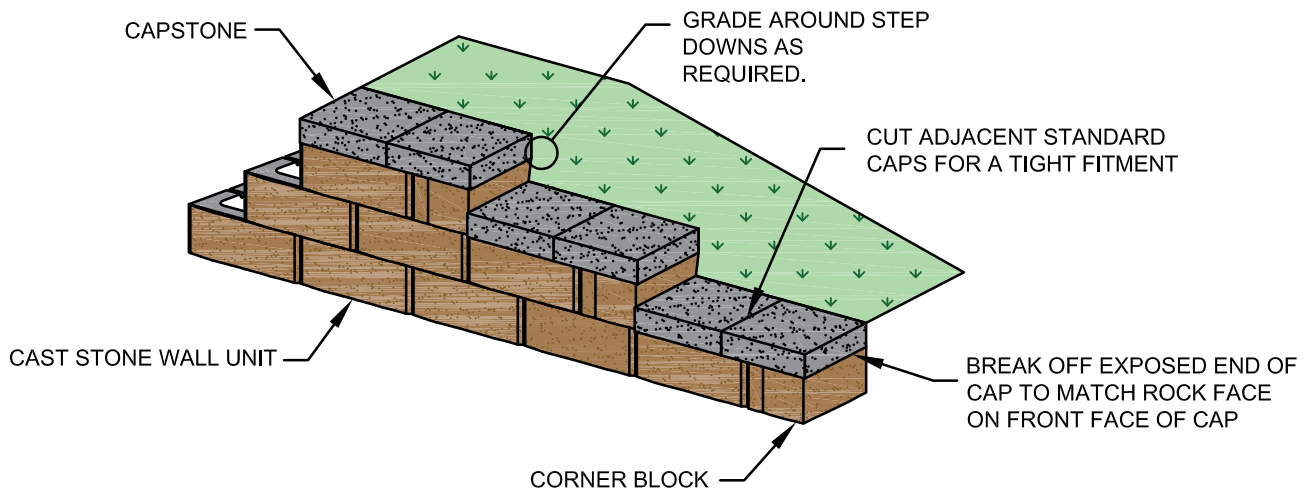
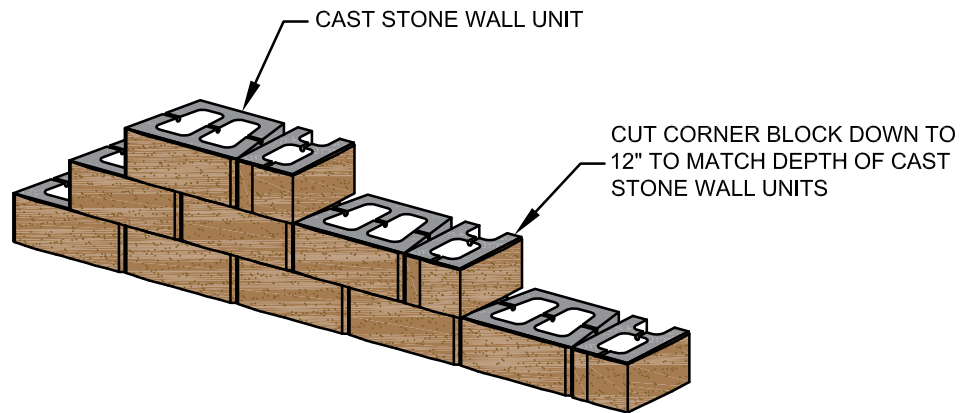

END CAP INSTALLATION AT WALL STEP

SINGLE SIDED CAST STONE WALL™ SOIL FRICTION ANGLE GRID CHART | 27°

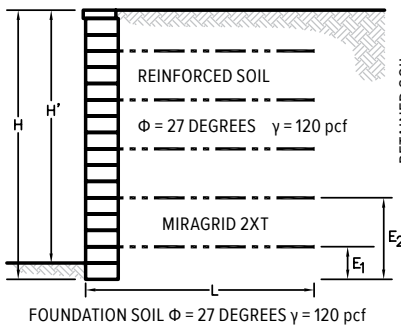
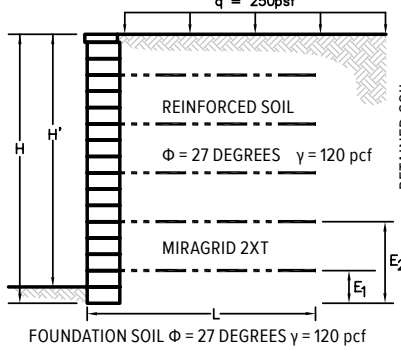
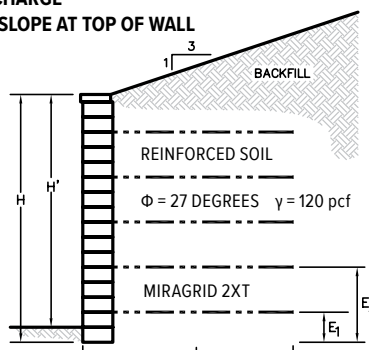
For grid estimating purposes only	Exposed Height H', (ft)	Total Height H, (ft)	No. of Cast Stone Courses	Grid Layers	Length L, (ft)	Layer Number - Place Grid at Elevation Ei (ft)									
						1	2	3	4	5	6	7			
Case 1 with $\phi = 27$ degrees NO SURCHARGE NO SLOPE AT TOP OF WALL 	1.8	2.3	4	1	4.0	1.0									
	2.3	2.8	5	1	4.0	1.0									
	2.8	3.3	6	2	4.0	1.0	2.0								
	3.3	3.8	7	2	4.0	1.0	2.5								
	3.8	4.3	8	2	4.0	1.0	2.5								
	4.3	4.8	9	3	5.0	1.0	2.5	3.5							
	4.8	5.3	10	3	5.0	1.0	2.5	3.5							
	5.3	5.8	11	3	5.0	1.0	2.5	4.0							
	5.8	6.3	12	4	6.0	1.0	2.5	4.0	5.0						
	6.3	6.8	13	4	6.0	1.0	2.5	4.0	5.0						
6.8	7.3	14	4	7.0	1.0	2.5	4.0	5.5							
7.3	7.8	15	5	7.0	1.0	2.5	4.0	5.5	6.5						
7.8	8.3	16	5	7.0	1.0	2.5	4.0	5.5	6.5						
8.3	8.8	17	5	7.5	1.0	2.5	4.0	5.5	7.0						
Case 2 with $\phi = 27$ degrees SURCHARGE FROM ROADWAY OR PARKING NO SLOPE AT TOP OF WALL 	1.8	2.3	4	1	5.0	0.5									
	2.3	2.8	5	2	5.0	0.5	1.5								
	2.8	3.3	6	2	5.5	1.0	2.0								
	3.3	3.8	7	2	5.5	1.0	2.0								
	3.8	4.3	8	2	6.5	1.0	2.5								
	4.3	4.8	9	3	6.5	1.0	2.5	3.5							
	4.8	5.3	10	3	7.5	1.0	2.5	4.0							
	5.3	5.8	11	3	7.5	1.0	2.5	4.0							
	5.8	6.3	12	4	7.5	1.0	2.5	4.0	5.0						
	6.3	6.8	13	4	8.5	1.0	2.5	4.0	5.5						
6.8	7.3	14	4	8.5	1.0	2.5	4.0	5.5							
7.3	7.8	15	5	9.0	1.0	2.5	4.0	5.5	6.5						
7.8	8.3	16	5	9.0	1.0	2.5	4.0	5.5	6.5						
8.3	8.8	17	5	9.5	1.0	2.5	4.0	5.5	7.0						
Case 3 with $\phi = 27$ degrees NO SURCHARGE 3:1 MAX SLOPE AT TOP OF WALL 	1.8	2.3	4	1	4.0	1.0									
	2.3	2.8	5	1	4.0	1.0									
	2.8	3.3	6	2	4.0	1.0	2.0								
	3.3	3.8	7	2	4.5	1.0	2.5								
	3.8	4.3	8	2	4.5	1.0	2.5								
	4.3	4.8	9	3	6.0	1.0	2.5	3.5							
	4.8	5.8	11*	3	6.0	1.0	2.5	4.0							
	5.3	6.3	12*	3	7.0	1.0	2.5	4.0	5.0						
	5.8	6.8	13*	4	7.0	1.0	2.5	4.0	5.0						
	6.3	7.3	14*	4	8.5	1.0	2.5	4.0	5.5						
6.8	7.8	15*	4	8.5	1.0	2.5	4.0	5.5	6.5						
7.3	8.3	16*	5	8.5	1.0	2.5	4.0	5.5	6.5						
7.8	8.8	17*	5	9.0	1.0	2.5	4.0	5.5	7.0						

*REQUIRES TWO FULL COURSES BURIED

NOTES:

- Information presented in this chart is to be used for preliminary design and estimating purposes. Final design should be performed by a Professional Engineer qualified in both geotechnical engineering and segmental retaining wall design.
- This estimating chart is applicable to sites where soil conditions meet the following minimum criteria: Angle of Internal Friction, $\phi > 27^\circ$ and moist unit weight, $\gamma = 120$ pcf. Typical for low plasticity silts meeting the following USCS classification: ML or coarser.
- Design charts prepared for use with EP Henry's Cast Stone Wall block system with Mirafi's type 2XT reinforcing geogrids. Grids MUST extend to the front face of the block.

4. Definitions:

- H = total height, in feet
- L = length of Mirafi 2XT required, in feet
- ϕ = angle of internal friction, degrees
- γ = moist unit weight, pounds per cubic foot
- Ei = elevation of grid layer from bottom of wall, in feet

- These charts do not reflect any provisions for global stability or other analyses, which may be related to site-specific conditions including relief of excess hydrostatic pressures due to groundwater or springs. All these conditions should be checked and evaluated as appropriate, using site specific soil and subsurface conditions, as well as any special loading criteria.
- Design Minimum Factors of Safety: 1.5 for reinforcement

pullout, 1.5 for external sliding, 2.0 for overturning, and 2.0 for bearing.

- All walls shall be supported on an aggregate leveling pad and shall have adequate drainage provisions in accordance with EP Henry's standard specification guidelines.
- To the best of our knowledge, the information presented in this design chart is complete and accurate. However, EP Henry Corporation cannot assume any liability or accept any responsibility for the accuracy or completeness of this information. Further, EP Henry Corporation cannot assume any liability for damages arising from claims in which construction proceeded without final design drawings prepared by a Professional Engineer registered in the State of construction specializing in both geotechnical engineering and segmental retaining wall design.

SINGLE SIDED CAST STONE WALL™

30° | SOIL FRICTION ANGLE GRID CHART

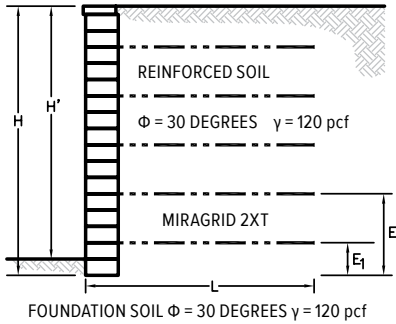
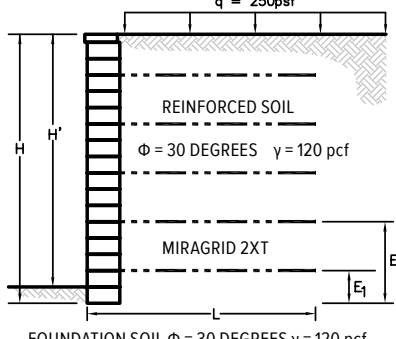
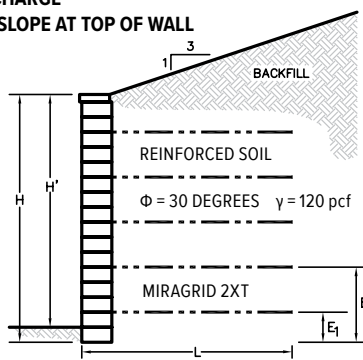
For grid estimating purposes only	Exposed Height H', (ft)	Total Height H, (ft)	No. of Cast Stone Courses	Grid Layers	Length L, (ft)	Layer Number - Place Grid at Elevation Ei (ft)									
						1	2	3	4	5	6	7			
Case 1 with $\phi = 30$ degrees NO SURCHARGE NO SLOPE AT TOP OF WALL 	2.3	2.8	5	1	4.0	1.0									
	2.8	3.3	6	2	4.0	1.0	2.0								
	3.3	3.8	7	2	4.0	1.0	2.5								
	3.8	4.3	8	2	4.0	1.0	2.5								
	4.3	4.8	9	3	4.5	1.0	2.5	3.5							
	4.8	5.3	10	3	4.5	1.0	2.5	3.5							
	5.3	5.8	11	3	5.5	1.0	2.5	4.0							
	5.8	6.3	12	4	5.5	1.0	2.5	4.0	5.0						
	6.3	6.8	13	4	5.5	1.0	2.5	4.0	5.0						
	6.8	7.3	14	4	6.5	1.0	2.5	4.0	5.5	6.5					
Case 2 with $\phi = 30$ degrees SURCHARGE FROM ROADWAY OR PARKING NO SLOPE AT TOP OF WALL 	1.8	2.3	4	1	4.0	0.5									
	2.3	2.8	5	2	4.0	0.5	1.5								
	2.8	3.3	6	2	4.5	1.0	2.0								
	3.3	3.8	7	2	4.5	1.0	2.0								
	3.8	4.3	8	2	5.5	1.0	2.5								
	4.3	4.8	9	3	5.5	1.0	2.5	3.5							
	4.8	5.3	10	3	5.5	1.0	2.5	3.5							
	5.3	5.8	11	3	6.5	1.0	2.5	4.0							
	5.8	6.3	12	4	6.5	1.0	2.5	4.0	5.0						
	6.3	6.8	13	4	6.5	1.0	2.5	4.0	5.0						
Case 3 with $\phi = 30$ degrees NO SURCHARGE 3:1 MAX SLOPE AT TOP OF WALL 	1.8	2.3	4	1	4.0	1.0									
	2.3	2.8	5	1	4.0	1.0									
	2.8	3.3	6	2	4.0	1.0	2.0								
	3.3	3.8	7	2	4.5	1.0	2.5								
	3.8	4.3	8	2	4.5	1.0	2.5								
	4.3	4.8	9	3	6.0	1.0	2.5	3.5							
	4.8	5.8	11	3	6.0	1.0	2.5	4.0							
	5.3	6.3	12	4	7.0	1.0	2.5	4.0	5.0						
	5.8	6.8	13	4	7.0	1.0	2.5	4.0	5.0						
	6.3	7.3	14	4	7.0	1.0	2.5	4.0	5.5	6.5					

*REQUIRES TWO FULL COURSES BURIED

- NOTES:**
- Information presented in this chart is to be used for preliminary design and estimating purposes. Final design should be performed by a Professional Engineer qualified in both geotechnical engineering and segmental retaining wall design.
 - This estimating chart is applicable to sites where soil conditions meet the following minimum criteria: Angle of Internal Friction, $\phi > 30^\circ$ and moist unit weight, $\gamma = 120\text{pcf}$. Typical for low plasticity silts meeting the following USCS classification: ML or coarser.
 - Design charts prepared for use with EP Henry's Cast Stone Wall block system with Mirafi's type 2XT reinforcing geogrids. Grids MUST extend to the front face of the block.
 - Definitions:
 H' = exposed height, in feet
 H = total height, in feet
 L = length of Mirafi 2XT required, in feet
 ϕ = angle of internal friction, degrees
 γ = moist unit weight, pounds per cubic foot
 Ei = elevation of grid layer from bottom of wall, in feet
 - These charts do not reflect any provisions for global stability or other analyses, which may be related to site-specific conditions including relief of excess hydrostatic pressures due to groundwater or springs. All these conditions should be checked and evaluated as appropriate, using site specific soil and subsurface conditions, as well as any special loading criteria.
 - Design Minimum Factors of Safety: 1.5 for reinforcement pullout, 1.5 for external sliding, 2.0 for overturning, and 2.0 for bearing.
 - All walls shall be supported on an aggregate leveling pad and shall have adequate drainage provisions in accordance with EP Henry's standard specification guidelines.
 - To the best of our knowledge, the information presented in this design chart is complete and accurate. However, EP Henry Corporation cannot assume any liability or accept any responsibility for the accuracy or completeness of this information. Further, EP Henry Corporation cannot assume any liability for damages arising from claims in which construction proceeded without final design drawings prepared by a Professional Engineer registered in the State of construction specializing in both geotechnical engineering and segmental retaining wall design.

SINGLE SIDED CAST STONE WALL™ SOIL FRICTION ANGLE GRID CHART | 32°

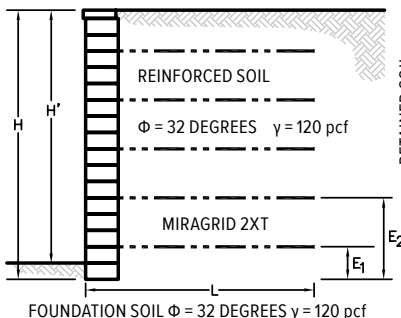
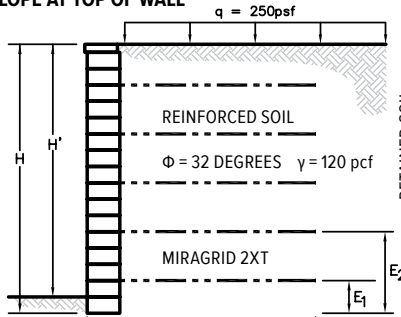
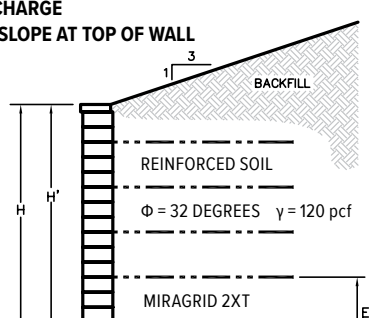
For grid estimating purposes only	Exposed Height H', (ft)	Total Height H, (ft)	No. of Cast Stone Courses	Grid Layers	Length L, (ft)	Layer Number - Place Grid at Elevation Ei (ft)									
						1	2	3	4	5	6	7			
Case 1 with $\phi = 32$ degrees NO SURCHARGE NO SLOPE AT TOP OF WALL 	2.3	2.8	5	1	4.0	1.5									
	2.8	3.3	6	1	4.0	1.5									
	3.3	3.8	7	2	4.0	1.5	2.5								
	3.8	4.3	8	2	4.0	1.5	3.0								
	4.3	4.8	9	2	4.0	1.5	3.0								
	4.8	5.3	10	3	5.0	1.5	3.0	4.0							
	5.3	5.8	11	3	5.0	1.5	3.0	4.5							
	5.8	6.3	12	3	5.0	1.5	3.0	4.5							
	6.3	6.8	13	4	6.0	1.5	3.0	4.5	5.5						
	6.8	7.3	14	4	6.0	1.5	3.0	4.5	6.0						
7.3	7.8	15	4	6.0	1.5	3.0	4.5	6.0							
7.8	8.3	16	5	7.0	1.5	3.0	4.5	6.0	7.0						
8.3	8.8	17	5	7.0	1.5	3.0	4.5	6.0	7.5						
8.3	8.8	17	5	7.5	1.0	2.5	4.0	5.5	7.0						
Case 2 with $\phi = 32$ degrees SURCHARGE FROM ROADWAY OR PARKING NO SLOPE AT TOP OF WALL 	1.8	2.3	4	1	4.0	1.0									
	2.3	2.8	5	1	4.0	1.0									
	2.8	3.3	6	2	4.0	1.0	2.0								
	3.3	3.8	7	2	4.0	1.0	2.0								
	3.8	4.3	8	2	5.0	1.0	2.5								
	4.3	4.8	9	3	5.0	1.0	2.5	3.5							
	4.8	5.3	10	3	5.0	1.0	2.5	3.5							
	5.3	5.8	11	3	6.0	1.0	2.5	4.0							
	5.8	6.3	12	4	6.0	1.0	2.5	4.0	5.0						
	6.3	6.8	13	4	6.0	1.0	2.5	4.0	5.0						
6.8	7.3	14	4	7.0	1.0	2.5	4.0	5.5							
7.3	7.8	15	5	7.0	1.0	2.5	4.0	5.5	6.5						
7.8	8.3	16	5	7.0	1.0	2.5	4.0	5.5	6.5						
8.3	8.8	17	5	8.0	1.0	2.5	4.0	5.5	7.0						
Case 3 with $\phi = 32$ degrees NO SURCHARGE 3:1 MAX SLOPE AT TOP OF WALL 	1.8	2.3	4	1	4.0	1.0									
	2.3	2.8	5	1	4.0	1.5									
	2.8	3.3	6	1	4.0	1.5									
	3.3	3.8	7	2	4.0	1.5	2.5								
	3.8	4.3	8	2	4.0	1.5	2.5								
	4.3	4.8	9	2	5.5	1.5	3.0								
	4.8	5.8	11	3	5.5	1.5	3.0	4.0							
	5.3	6.3	12	3	6.5	1.5	3.0	4.5							
	5.8	6.8	13	4	6.5	1.5	3.0	4.5	5.5						
	6.3	7.3	14	4	6.5	1.5	3.0	4.5	5.5						
6.8	7.8	15	4	7.0	1.5	3.0	4.5	6.0							
7.3	8.3	16	5	8.0	1.5	3.0	4.5	6.0	7.0						
7.8	8.8	17	5	8.0	1.5	3.0	4.5	6.0	7.5						

*REQUIRES TWO FULL COURSES BURIED

NOTES:

- Information presented in this chart is to be used for preliminary design and estimating purposes. Final design should be performed by a Professional Engineer qualified in both geotechnical engineering and segmental retaining wall design.
- This estimating chart is applicable to sites where soil conditions meet the following minimum criteria: Angle of Internal Friction, $\phi > 32^\circ$ and moist unit weight, $\gamma = 120\text{pcf}$. Typical for low plasticity silts meeting the following USCS classification: ML or coarser.
- Design charts prepared for use with EP Henry's Cast Stone Wall block system with Mirafi's type 2XT reinforcing geogrids. Grids MUST extend to the front face of the block.

4. Definitions:

- H' = exposed height, in feet
 - H = total height, in feet
 - L = length of Mirafi 2XT required, in feet
 - ϕ = angle of internal friction, degrees
 - γ = moist unit weight, pounds per cubic foot
 - Ei = elevation of grid layer from bottom of wall, in feet
- These charts do not reflect any provisions for global stability or other analyses, which may be related to site-specific conditions including relief of excess hydrostatic pressures due to groundwater or springs. All these conditions should be checked and evaluated as appropriate, using site specific soil and subsurface conditions, as well as any special loading criteria.
 - Design Minimum Factors of Safety: 1.5 for reinforcement

pullout, 1.5 for external sliding, 2.0 for overturning, and 2.0 for bearing.

- All walls shall be supported on an aggregate leveling pad and shall have adequate drainage provisions in accordance with EP Henry's standard specification guidelines.
- To the best of our knowledge, the information presented in this design chart is complete and accurate. However, EP Henry Corporation cannot assume any liability or accept any responsibility for the accuracy or completeness of this information. Further, EP Henry Corporation cannot assume any liability for damages arising from claims in which construction proceeded without final design drawings prepared by a Professional Engineer registered in the State of construction specializing in both geotechnical engineering and segmental retaining wall design.

DOUBLE SIDED CAST STONE WALL



Double Sided Cast Stone Wall Breckenridge;
Devonstone Bluestone Caps



Adirondack, Full Face



Aspen, Random Face



Birch, Random Face



Breckenridge, Mixed Face

16" Double Sided Cast Stone Wall is now available in Full Face Pallet — same cubing as 16" Random Face

All units are
6" high.



D/S CAST STONE WALL

	A	B	C	C REDUCED QTY PALLET
SIZE (LxD)	6" x 7"±	10" x 7"±	16" x 7"±	16" x 7"±
SF PER CUBE		9	30	15
PCS PER CUBE	27	27	90	45
LBS PER PIECE	12	22	39	39
LBS PER CUBE		932	3,444	1,728

D/S CAST STONE WALL TERMINATION

	A	B
SIZE (LxD)	8" x 8"	16" x 6"
PCS PER CUBE	24	24
TOTAL LBS PER CUBE	1,544	

NOTES

A & B Stretcher sold together in one cube and A & B Corner sold together in one cube.
± Depth will vary due to the random thickness of the face shell

- 6" unit = .25 sf
- 10" unit = .42 sf



DOUBLE SIDED CAST STONE WALL INSTALLATION GUIDE

GENERAL INSTALLATION GUIDELINES:

Recommended maximum height: 4 courses (24") exposed not including cap. Install all courses of Double Sided Cast Stone Wall block with a gap of 1" separating the back of the blocks of the opposing walls.

High strength concrete adhesive is required between every course and the cap. EP Henry recommends the use of Techniseal Structure Bond Adhesive. The 10" and 6" units will allow construction of radius walls with virtually no cuts.

CALCULATE MATERIAL NEEDED

Double Sided Cast Stone Wall™ is sold by the square foot. Calculate the total square feet of Double Sided Cast Stone Wall™ needed by multiplying the length times the exposed height for one side of the wall.

Double Sided Cast Stone Wall™ has its own Footer Block which is sold by the piece. Calculate the number of units needed by dividing the length of the wall in feet by 1.30 (decimal equivalent of 15 5/8").

PREPARE THE FOOTING

Dig a trench 24" wide and 10" below finished grade. Make sure the soil at the bottom of the trench is well compacted to prevent settling. In heavy or clay soils for best results, wrap the footer trench in a "U" shape configuration with geotextile. This will preserve the stone base over time and keep it from migrating into the clay soil. Using a vibratory plate compactor, install 6" of dense graded aggregate (modified stone) or clean #57 stone in two 3" lifts making sure the surface of the last lift is smooth and level.

Tip: If using dense graded aggregate or modified stone: add a 1" layer of concrete sand or stone screenings on top of the footing as a leveling agent for the footer course.

INSTALLING THE FOOTER COURSE BLOCK

Install the Double Sided Cast Stone Wall™ Footer Block™ by placing the units tightly together on the prepared base.

Align the units so the long dimension of the Double Sided Cast Stone Wall Footer Block™ runs parallel to the length of the footer trench. Level the units from front-to-back and side-to-side using a dead blow hammer and level. Radius construction will require the base course block to be spread apart (the gap should not exceed 4") and/or to be cut and trimmed accordingly using a diamond blade saw.

INSTALLING DOUBLE SIDED CAST STONE WALL

Install the first course of Double Sided Cast Stone Wall™ block with the face of the unit overhanging the footer block while maintaining a gap of 1" separating the back of the blocks of the opposing walls. The face of the block on top of the course of Double Sided Cast Stone Wall Footer Block™ will overhang the footer block by about 1". Check to make sure all units are level front-to-back, side-to-side and wall-to-wall. Install courses whenever possible so that each block spans the two units below it in a running bond pattern. Avoid having a vertical line extend more than two courses of block. Install additional courses starting at the corner and working toward the other end. Do not start at both corners and try to meet in the middle. Install the faces of the blocks flush to avoid gaps and to keep the continuity of the stone face on both sides of the wall. It is necessary to bond all the courses of block, the footer block, and the cap together. To achieve structural stability, beads of high strength, flexible concrete adhesive must be run between each course staying 1"– 2" behind the face of the block. EP Henry recommends the use of Techniseal Structure Bond Adhesive.



BLOCK ALIGNMENT

CAUTION: DRY SAWING OR GRINDING OF CONCRETE PRODUCTS MAY RESULT IN THE RELEASE OF RESPIRABLE CRYSTALLINE QUARTZ. PROLONGED EXPOSURE TO RESPIRABLE CRYSTALLINE QUARTZ MAY CAUSE DELAYED (CHRONIC) LUNG INJURY (SILICOSIS). THE USE OF A NIOSH-APPROVED RESPIRATOR AND TIGHT-FITTING GOGGLES ARE RECOMMENDED WHEN SAWING OR GRINDING OPERATIONS ARE IN PROGRESS.

DOUBLE SIDED CAST STONE WALL INSTALLATION GUIDE

TERMINATING THE WALL

Double Sided Cast Stone Wall™ corners are manufactured in two unit sizes—8”x8” (A) and 16”x6” (B)— to readily terminate the wall. At the termination point of the wall place the long and short corner units back-to-back as opposing pairs to create the end of the wall. (See photo at right.) Alternate the position of the corner units on each successive course to maintain a running bond pattern. When terminating the wall make sure that the corner units overlap the two corner blocks beneath them maintaining a running bond.

WALL TERMINATION COURSES

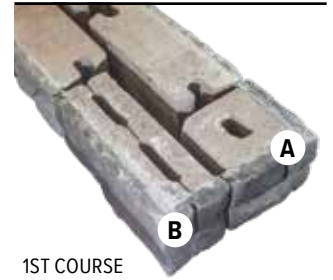

1ST COURSE



2ND COURSE



3RD COURSE

BUILDING 90° CORNERS

To build 90° corners install a Double Sided Cast Stone Wall™ “A” corner unit at the spot where one wall will terminate and the return wall begins. Work off of the “A” Corner unit using the 16” stretcher units. For each successive course of block alternate the position of the “A” Corner unit (see below). It is recommended to start construction at the corner and work out from that point. This insures virtually no cut pieces at the corner which means better structural stability and a cleaner overall appearance. Use a high-strength flexible concrete adhesive on all Double Sided Cast Stone Wall™ units when constructing the 90° corner.

CAPPING THE WALL

After laying the last course of wall block, install the wall cap units using a high strength, flexible concrete adhesive applied to both sides of the wall. The cap units should be installed following the contour of the wall and with a uniform overhang on both sides. If needed, use a shim to eliminate any minor variations in height between the wall caps. The EP Henry Double Sided Cast Stone Wall™ cap options can be installed by alternating the units front-to-back to cap a straight wall or by marrying the angles of the cap to conform to the wall’s radius. Cutting the cap units may be necessary depending on the radius. All of the cap options have available finished end units for terminating the wall.

NOTE: DOUBLE SIDED CAST STONE WALL™ MAY ALSO BE TERMINATED BY BUILDING A COLUMN AT THE END OF THE WALL USING SINGLE SIDED CAST STONE WALL™ CORNER UNITS WITH THE COLUMN CAP.



BUILDING 90° CORNERS

DOUBLE SIDED CAST STONE WALL CALCULATOR

WALL LENGTH		1'4"	2'8"	4'0"	5'4"	6'8"	8'0"	9'8"	10'8"	12'	13'4"	14'8"	16'	17'4"	18'8"	20'	21'4"	22'8"	24'	
		HEIGHTS BELOW ARE IN SQUARE FEET (SQ. FT.)																		
WALL HEIGHT	6" = 1 course	.66	1.3	2	2.7	3.3	4	4.7	5.3	6	6.7	7.3	8	8.7	9.3	10	10.7	11.3	12	
	1' = 2 courses	1.3	2.6	4	5.4	6.6	8	9.4	10.6	12	13.4	14.6	16	17.4	18.6	20	21.4	22.6	24	
	1'6" = 3 courses	2	3.9	6	8.1	9.9	12	14.1	15.9	18	20.1	21.9	24	26.1	27.9	30	32.1	33.9	36	
	2' = 4 courses	2.7	5.9	8	10.8	13.2	16	18.8	21.2	24	26.8	29.2	32	34.8	37.2	40	42.8	45.2	48	

To calculate the number of 16” stretcher units needed for both sides of the wall, using the chart above, multiply the square footage required by 3. For a wall 1'6” high and 16’ long, you would need 72 stretchers (1.5 x 16 = 24 sf; 24 sf x 3 = 72 Double Sided Cast Stone Wall Stretchers needed)

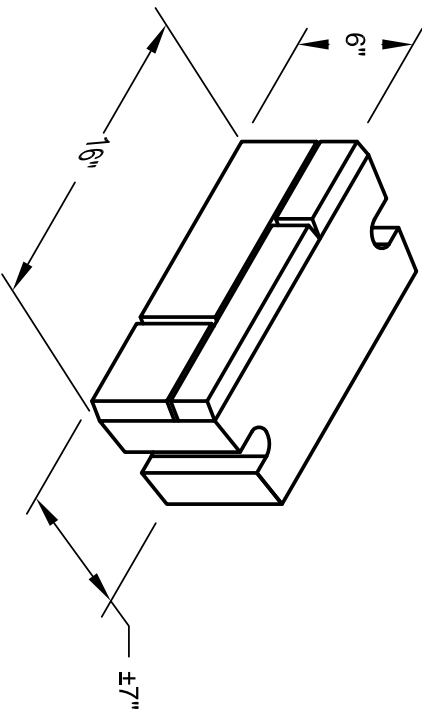

DS CAST STONE WALL
16" UNIT

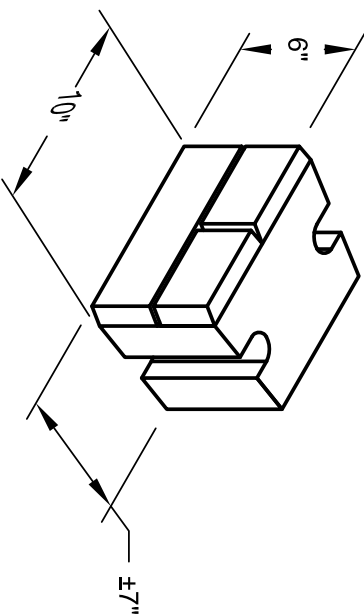

DS CAST STONE WALL
10" UNIT

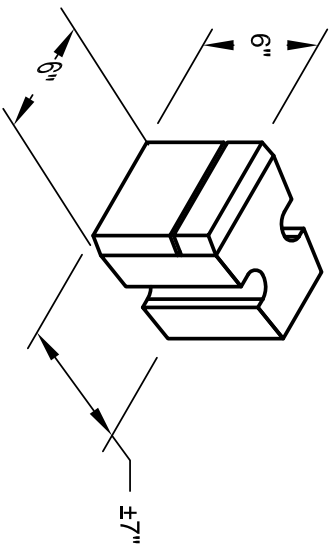

DS CAST STONE WALL
6" UNIT

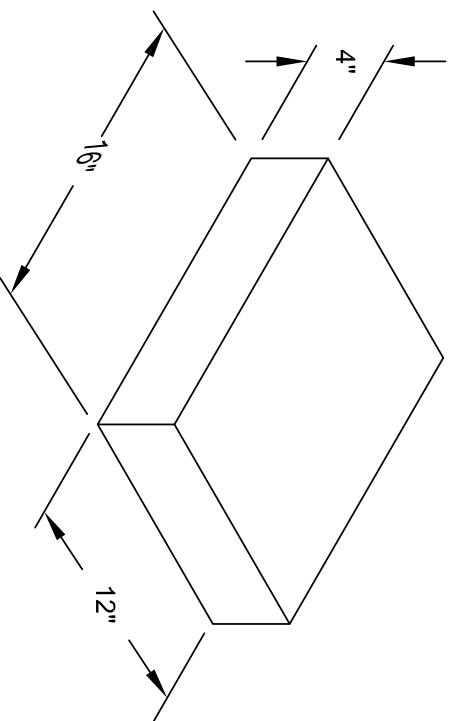

DS CAST STONE WALL
BASE BLOCK

NOTE:
ALL BASE COURSE UNITS SHALL BE DOUBLE-SIDED CAST STONE WALL BASE BLOCK

EPHENRY®

201 Park Ave.
Woodbury, NJ 08096
(800)-444-3679
www.ephentry.com

TITLE: DOUBLE-SIDED CAST STONE WALL
TYPICAL UNIT DETAIL

SCALE: NOT TO SCALE

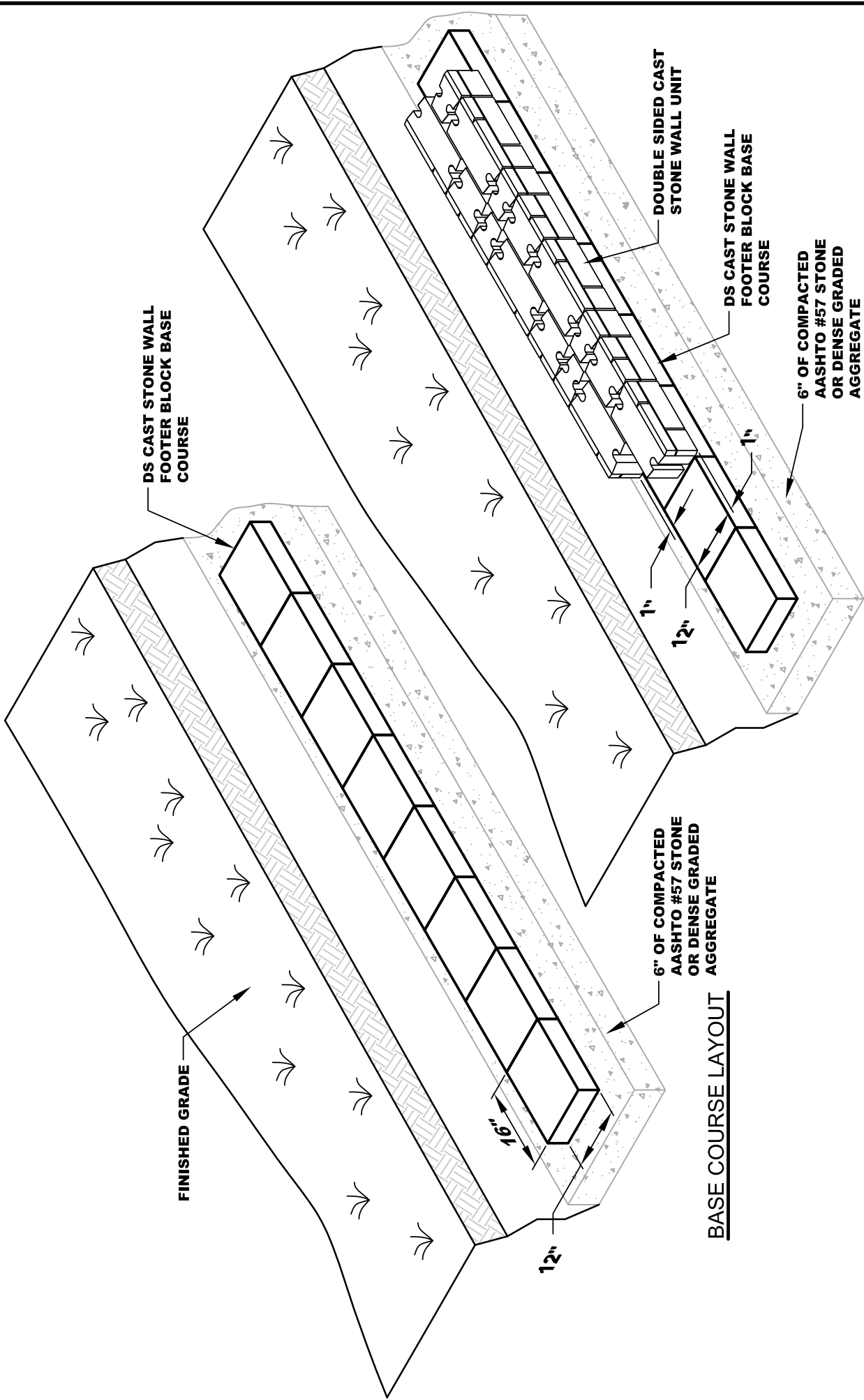

FIRST COURSE LAYOUT

TITLE: DOUBLE-SIDED CAST STONE WALL
BASE COURSE CONSTRUCTION DETAIL

SCALE: NOT TO SCALE

201 Park Ave.
Woodbury, NJ 08096
(800)-444-3679
www.ephenry.com



NOTES:

1. MAXIMUM 21" FREE STANDING WALL HEIGHT (NOT INCLUDING BURIED FOOTER BLOCK).
2. USE HIGH-STRENGTH CONCRETE ADHESIVE ON EACH BLOCK-TO-BLOCK CONTACT SURFACE AT EVERY SUCCESSIVE COURSE.
3. ENSURE UNITS ARE INSTALLED LEVEL FRONT-TO-BACK AND SIDE-TO-SIDE.
4. MAINTAIN $\pm 1"$ SPACE BETWEEN BACK-TO-BACK UNITS.

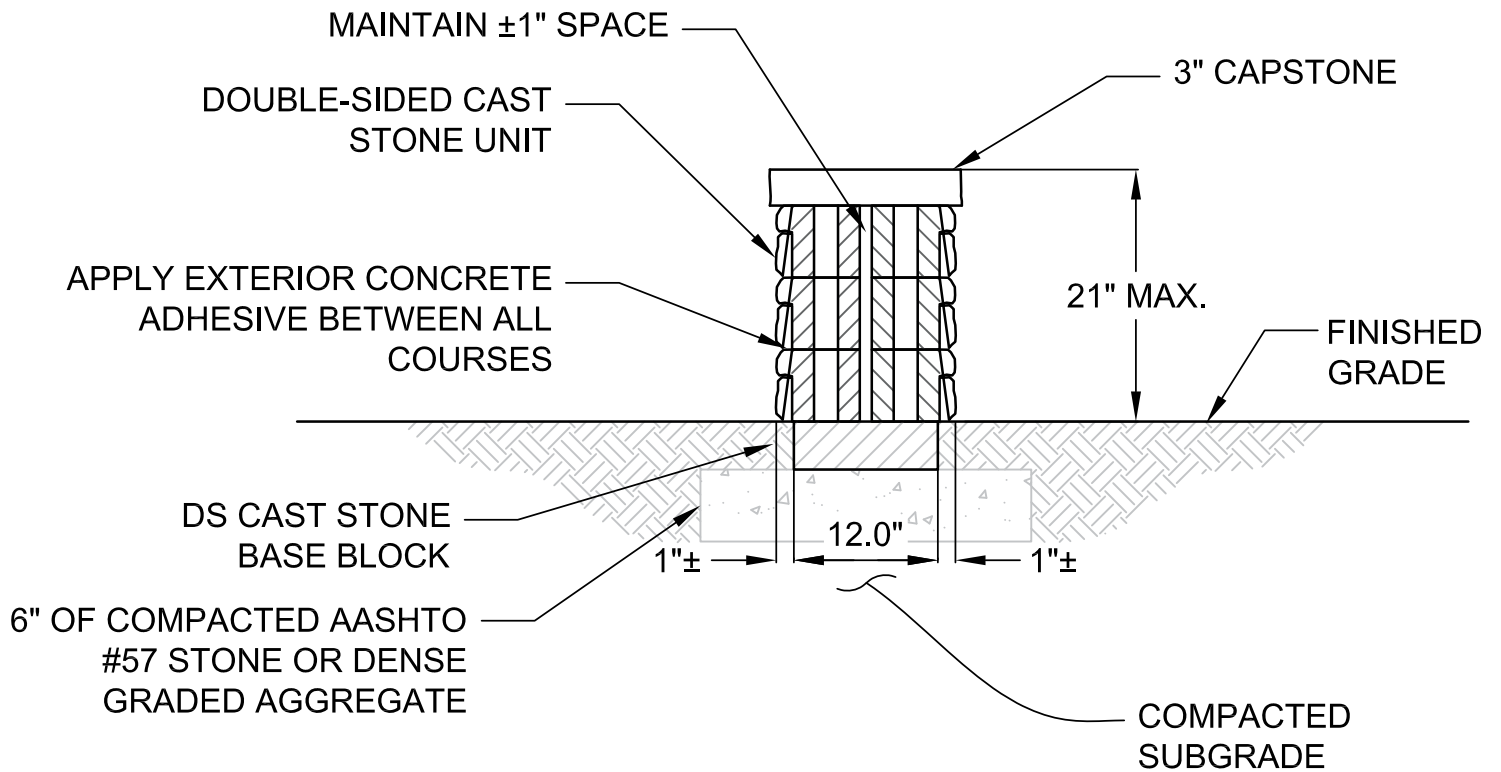

BLOCK ID TABLE	
A	7"(W)x6"(L)x6"(H)
B	7"(W)x10"(L)x6"(H)
C	7"(W)x16"(L)x6"(H)
CORNER A	6"(W)x16"(L)x8"(H)
CORNER B	8"(W)x8"(L)x8"(H)

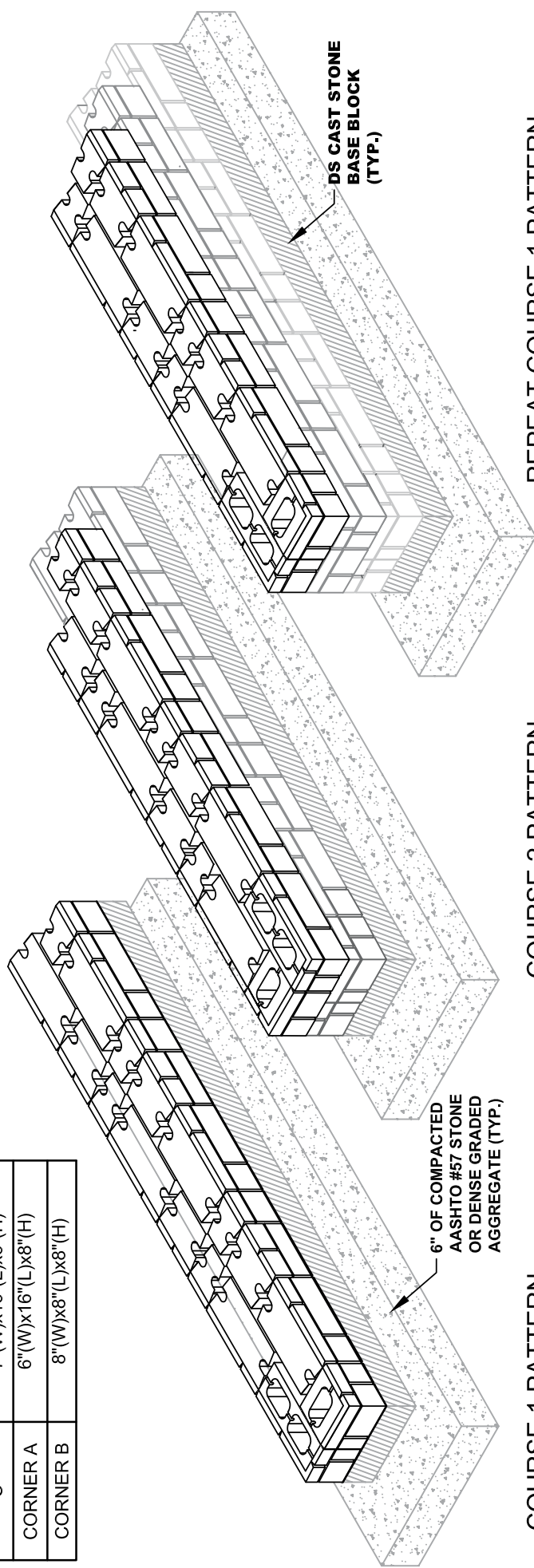

REPEAT COURSE 1 PATTERN
ISOMETRIC VIEW

COURSE 2 PATTERN
ISOMETRIC VIEW

COURSE 1 PATTERN
ISOMETRIC VIEW

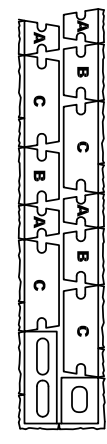

REPEAT COURSE 1 PATTERN
PLAN VIEW

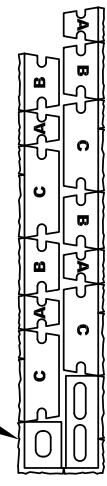

COURSE 2 PATTERN
PLAN VIEW

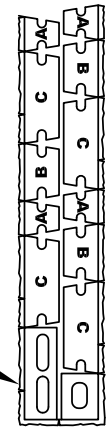

COURSE 1 PATTERN
PLAN VIEW

TITLE: DOUBLE-SIDED CAST STONE WALL
END-WALL CONSTRUCTION DETAIL

SCALE: NOT TO SCALE

201 Park Ave.
Woodbury, NJ 08096
(800)-444-3679
www.ephenny.com



BLOCK ID TABLE	
A	7"(W)x6"(L)x6"(H)
B	7"(W)x10"(L)x6"(H)
C	7"(W)x16"(L)x6"(H)

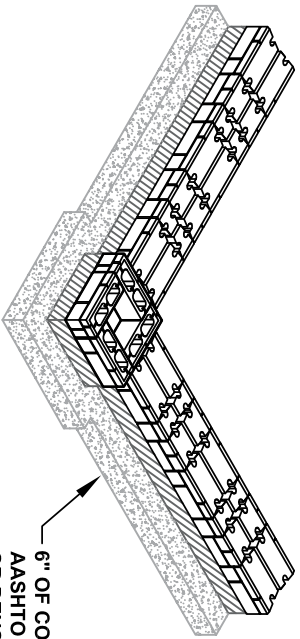

6" OF COMPACTED
AASHTO #57 STONE
OR DENSE GRADED
AGGREGATE (TYP.)

**COURSE 1 PATTERN
ISOMETRIC VIEW**

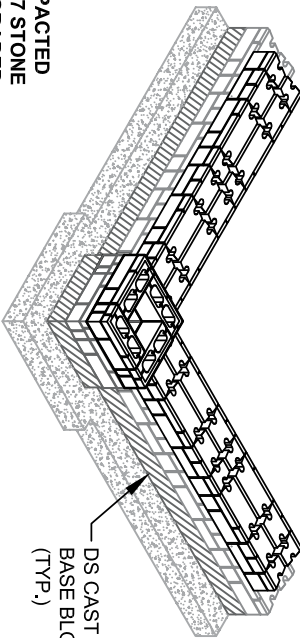

DS CAST STONE
BASE BLOCK
(TYP.)

**COURSE 2 PATTERN
ISOMETRIC VIEW**

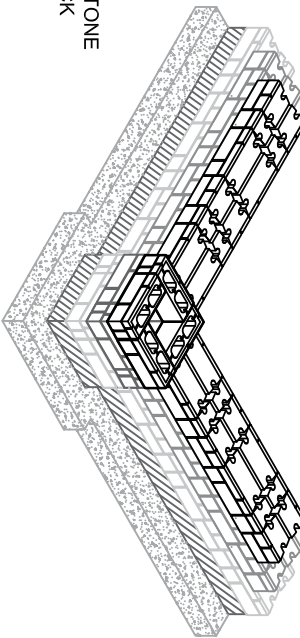

**REPEAT COURSE 1 PATTERN
ISOMETRIC VIEW**

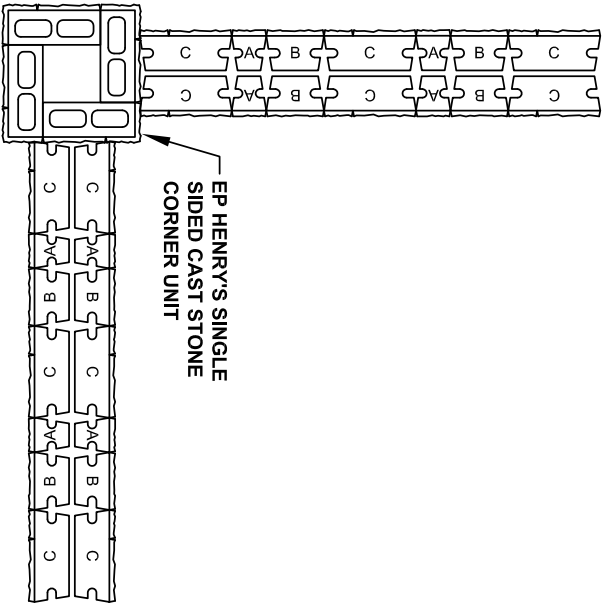

EP HENRY'S SINGLE
SIDED CAST STONE
CORNER UNIT

**COURSE 1 PATTERN
PLAN VIEW**

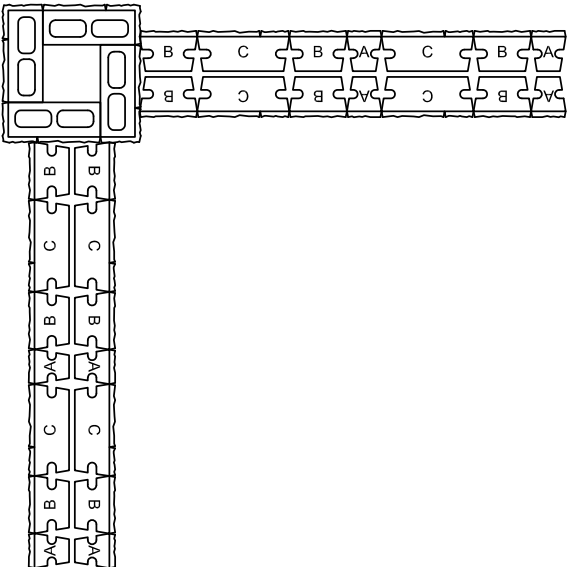

**COURSE 2 PATTERN
PLAN VIEW**

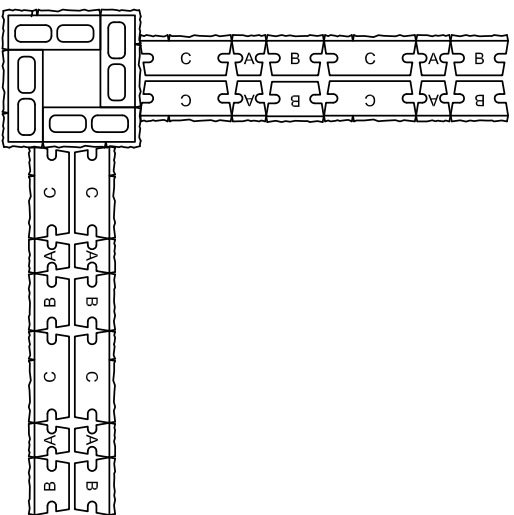

**REPEAT COURSE 1 PATTERN
PLAN VIEW**

TITLE:
DOUBLE-SIDED CAST STONE WALL
COLUMN CORNER CONSTRUCTION DETAIL

SCALE:
NOT TO SCALE

EP HENRY®

201 Park Ave.
Woodbury, NJ 08096
(800)-444-3679
www.ephenry.com

BLOCK ID TABLE	
A	7"(W)x6"(L)x6"(H)
B	7"(W)x10"(L)x6"(H)
C	7"(W)x16"(L)x6"(H)

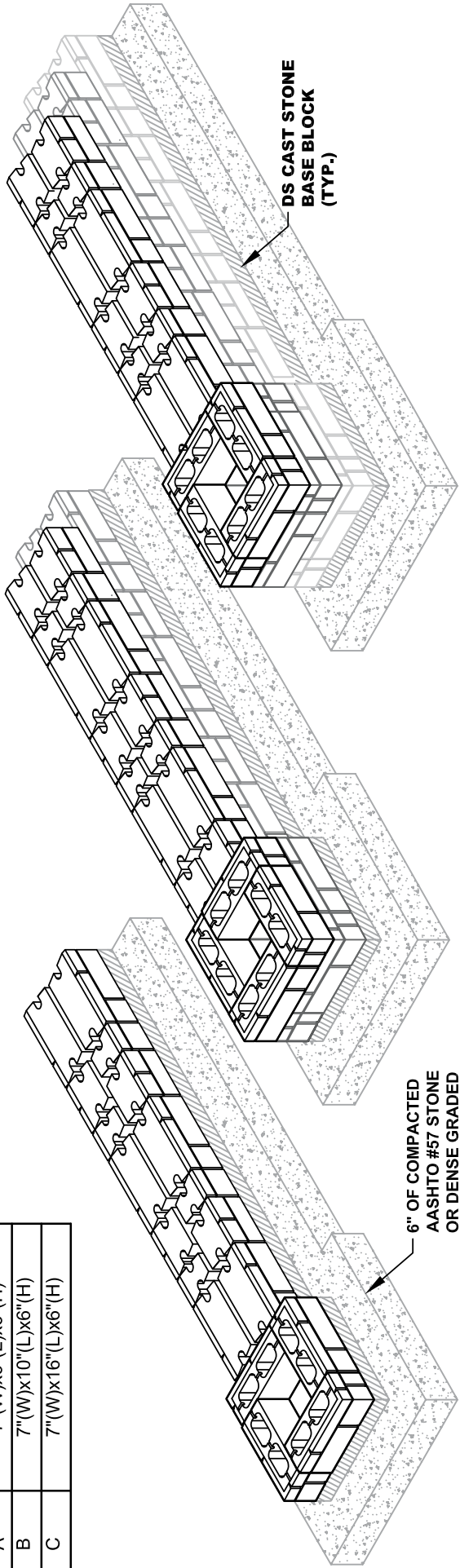

COURSE 1 PATTERN
ISOMETRIC VIEW

COURSE 2 PATTERN
ISOMETRIC VIEW

REPEAT COURSE 1 PATTERN
ISOMETRIC VIEW

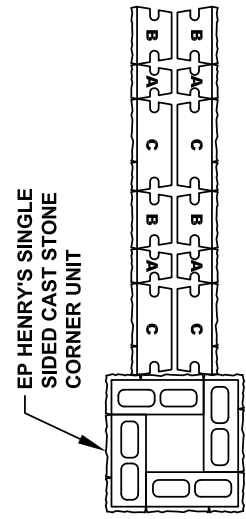

COURSE 1 PATTERN
PLAN VIEW

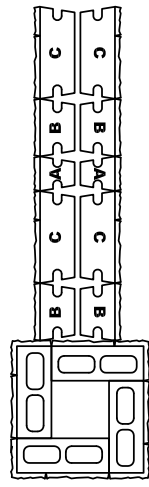

COURSE 2 PATTERN
PLAN VIEW

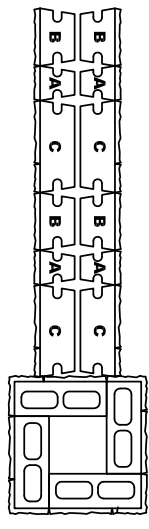

REPEAT COURSE 1 PATTERN
PLAN VIEW

201 Park Ave.
Woodbury, NJ 08096
(800)-444-3679
www.ephenry.com



TITLE: DOUBLE-SIDED CAST STONE WALL
COLUMN CORNER SINGLE WALL CONSTRUCTION DETAIL

SCALE: NOT TO SCALE

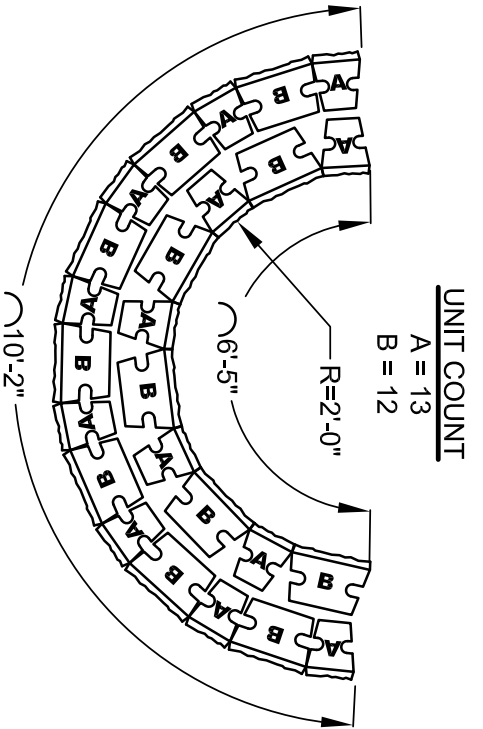

**DS CAST STONE WALL
2 FT RADIUS DETAIL**

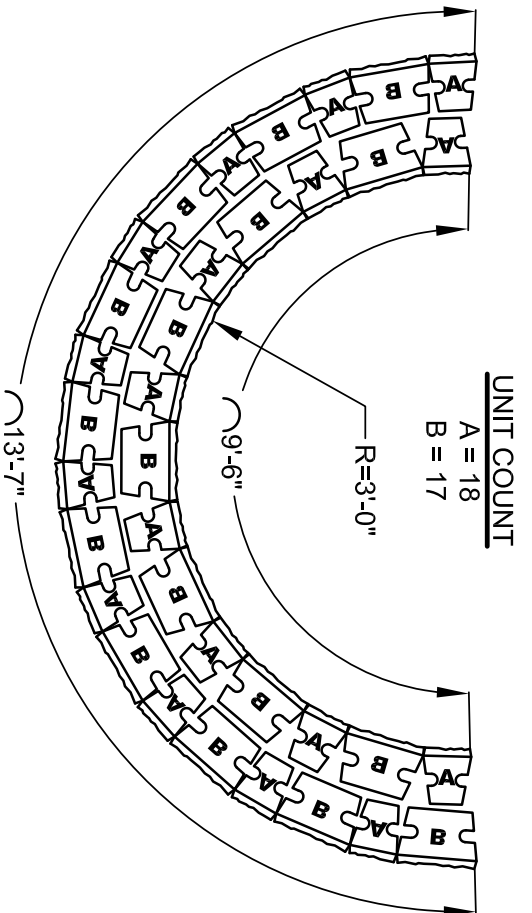

**DS CAST STONE WALL
3 FT RADIUS DETAIL**

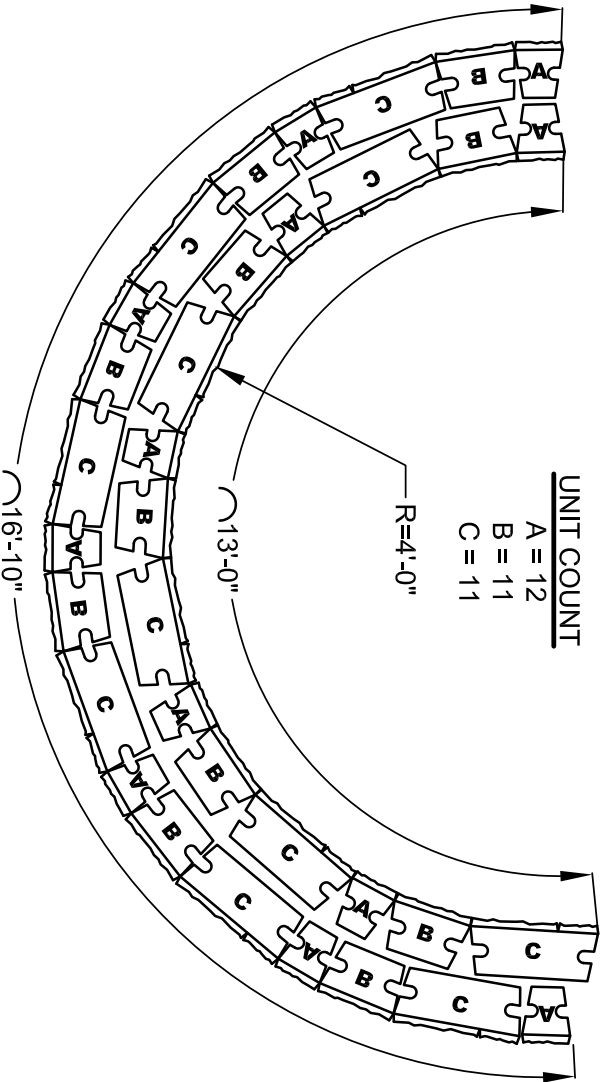

**DS CAST STONE WALL
4 FT RADIUS DETAIL**

BLOCK ID TABLE	
A	7"(W)x6"(L)x6"(H)
B	7"(W)x10"(L)x6"(H)
C	7"(W)x16"(L)x6"(H)

CPHENRY[®]

201 Park Ave.
Woodbury, NJ 08096
(800)-444-3679
www.cphenry.com

TITLE: DOUBLE-SIDED CAST STONE WALL
RADIUS DETAIL

SCALE: NOT TO SCALE

SPECIAL APPLICATIONS



Single Sided Cast Stone Wall and Fire Pit Kit
Breckenridge, Devonstone Bluestone Caps

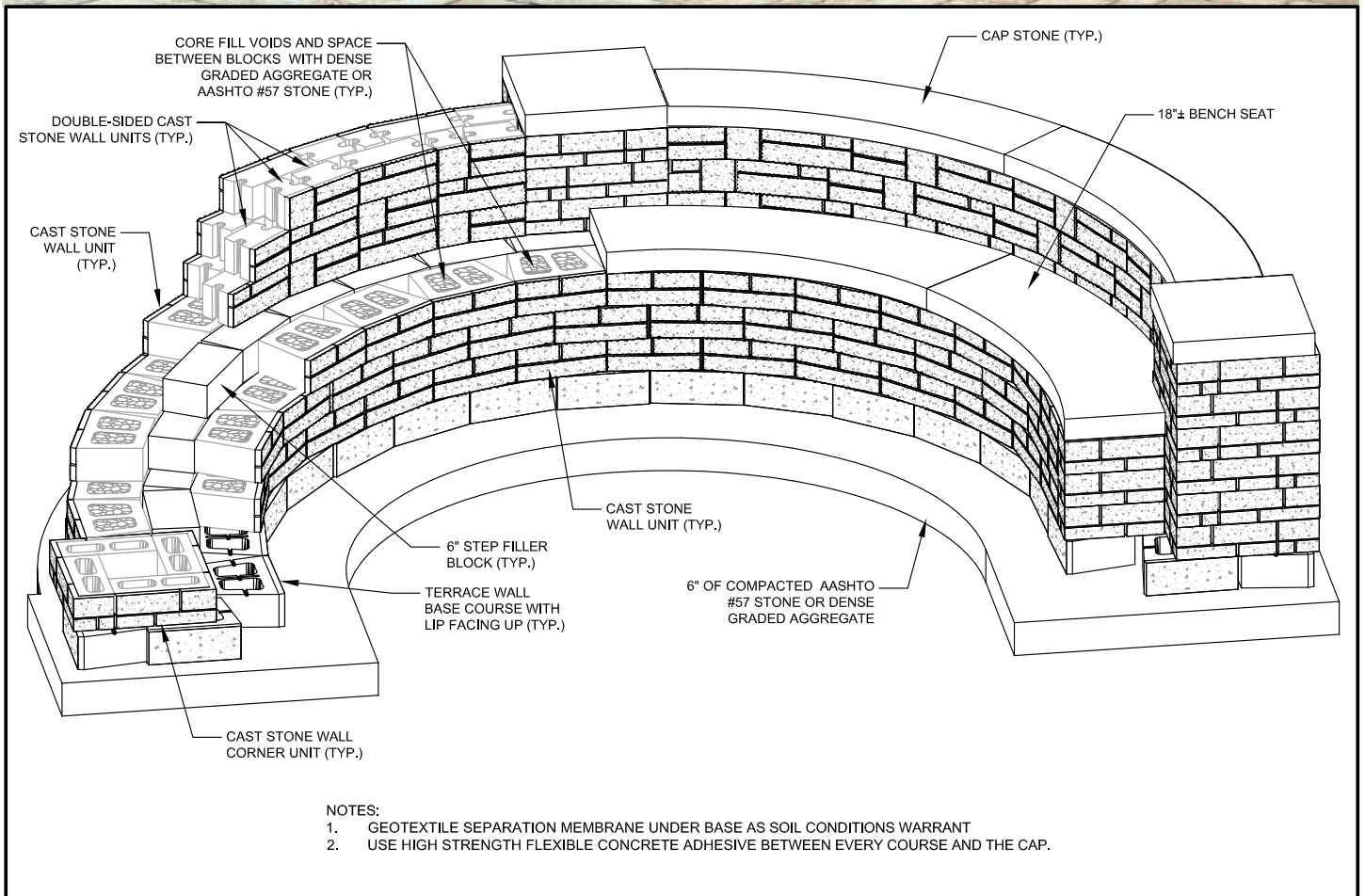

EP HENRY®

201 Park Ave.
Woodbury, NJ 08096
(800)-444-3679
www.ephentry.com

TITLE:
CAST STONE WALL SEATING WALL CONSTRUCTION DETAIL

SCALE:
NOT TO SCALE

STAGE 1

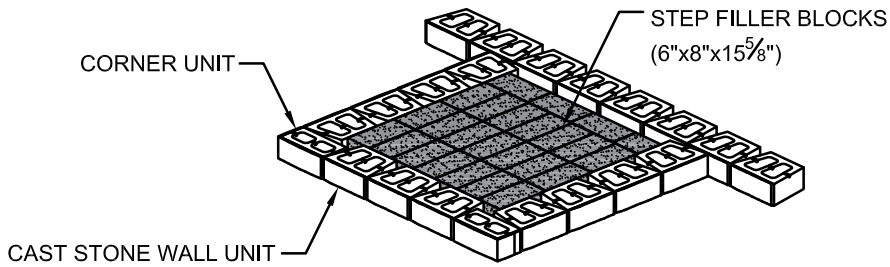

STAGE 2

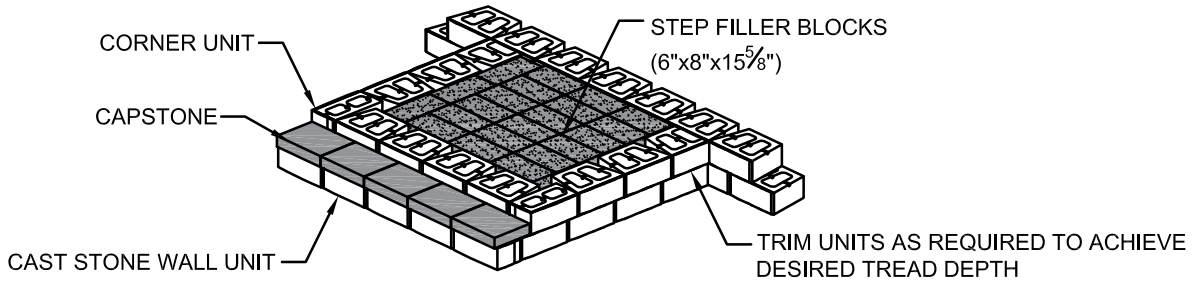

STAGE 3

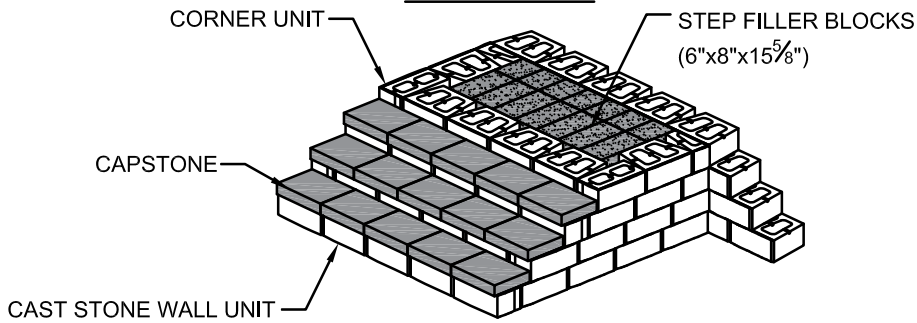

STAGE 4

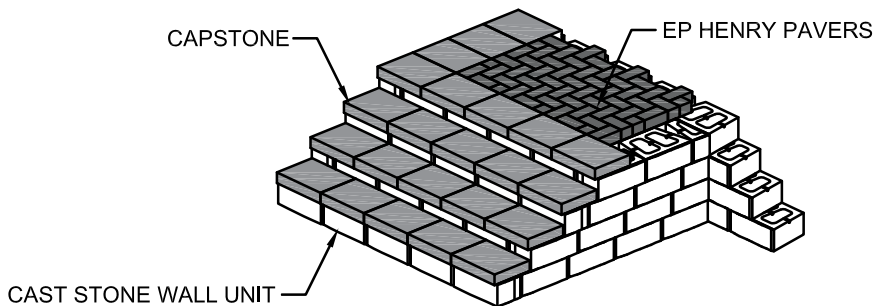

NOTES:

1. HIGH STRENGTH CONCRETE ADHESIVE SHALL BE USED BETWEEN UNITS ON EACH SUCCESSIVE COURSE BEGINNING AT THE TOP OF THE BASE UNITS.
2. STANDARD BASE COURSE & FOOTER PREPARATION REQUIRED.

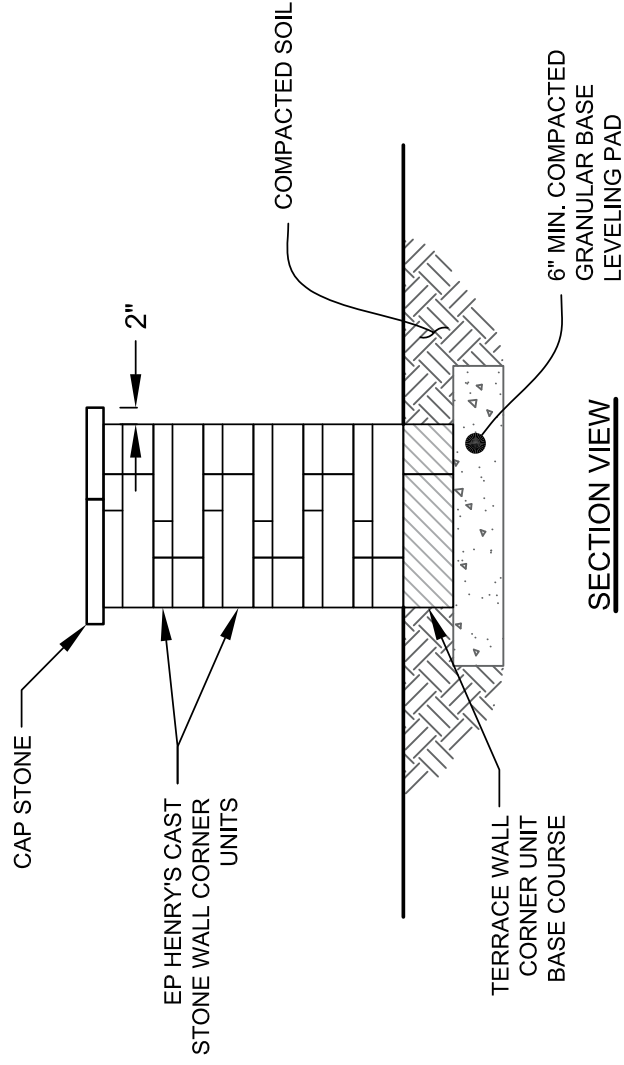
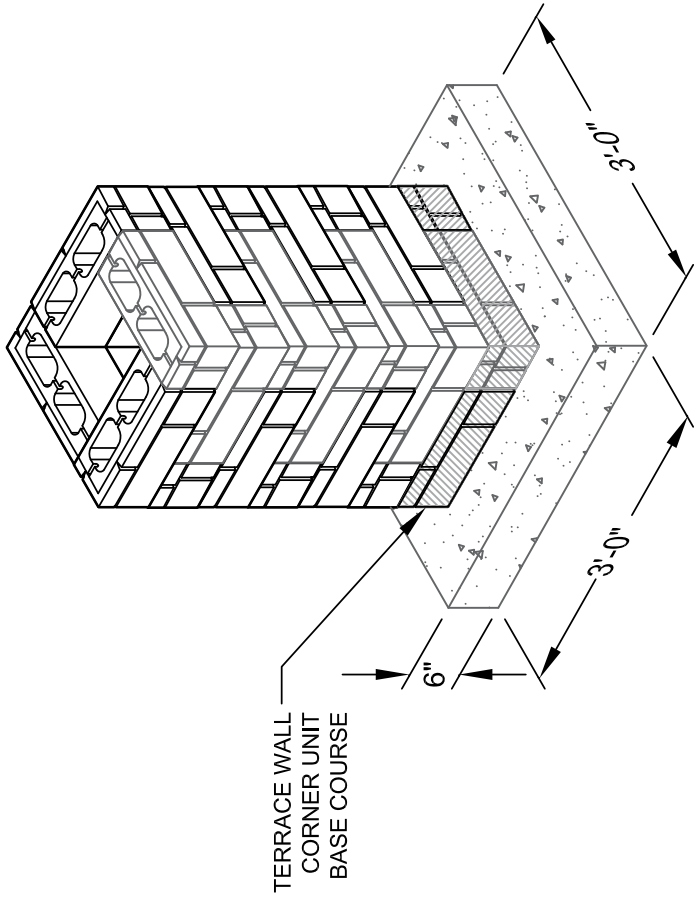

ISOMETRIC VIEW

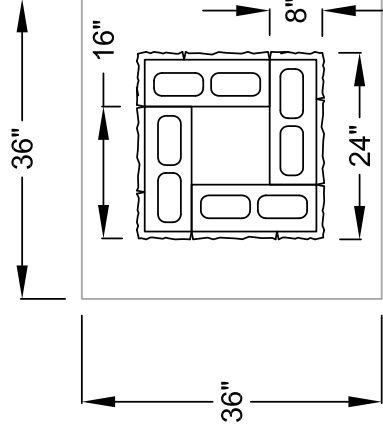

CAST STONE WALL CORNER UNIT

PLAN VIEW

TITLE:

201 Park Ave.
Woodbury, NJ 08096
(800)-444-3679
www.ephenny.com

CAST STONE WALL COLUMN DETAIL

SCALE:

NOT TO SCALE

EP HENRY®

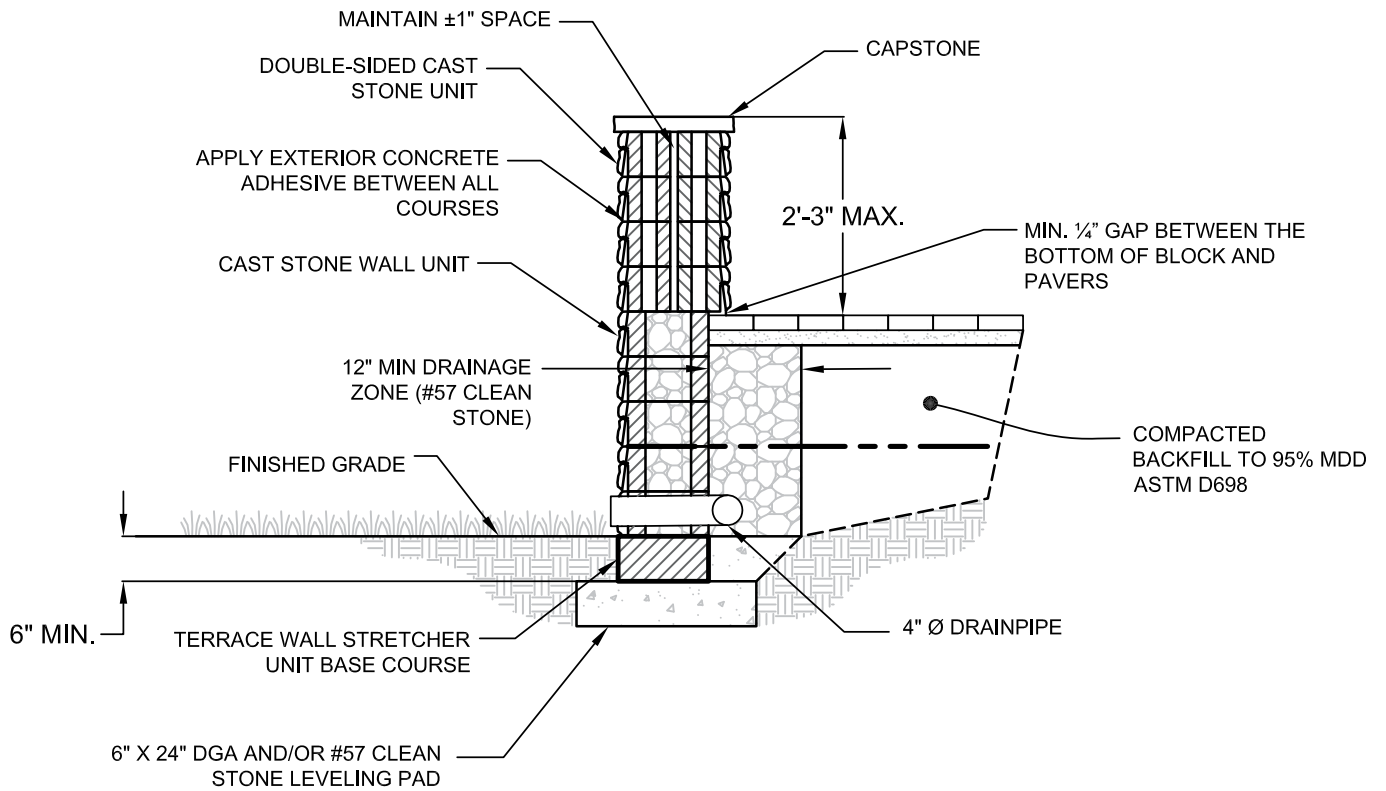

NOTE:
 IF RETAINING WALL IS 30" OR MORE IN HEIGHT OF SINGLE-SIDED WALL CHECK
 W/LOCAL CODE OFFICIALS FOR FALL PROTECTION REQUIREMENTS.

CAST STONE WALL FIRE PIT KIT



Cast Stone Wall Fire Pit Kit Adirondack



Adirondack, Full Face



Aspen, Random Face



Birch, Random Face



Breckenridge, Mixed Face

Fire Pit Kit Includes:

- 54 Wall Block
- 4 Caps
- Copper Bowl
- 36" Diameter Grate for Wood Burning
- 24" Diameter Grate for Cooking
- Poker
- Retractable Metal Mesh Dome
- Installation Guide (also available at www.ephentry.com)



CAP: Bluestone



CAP: Brownstone

FIRE PIT KIT

PCS PER CUBE
LBS PER PIECE
TOTAL LBS PER CUBE

27/EA 10" & 6" UNITS
22/12
1,126

IMPORTANT NOTE: BLOCK ARE NOT FIRE-RATED. DO NOT BURN FIRES WITHOUT THE PROTECTIVE BOWL OR ANOTHER FIRE-RATED INSERT. DO NOT OVERFILL THE BOWL; FIREWOOD SHOULD BE CONTAINED WITHIN THE CLOSED SPARK SCREEN.

NEW FOR 2018!

CAST STONE WALL SQUARE FIRE PIT KIT

Visit ephenry.com for more details.

NOTE: BEGIN WITH TWO 10" UNITS AND ALTERNATE 'A' & 'B' UNITS UNTIL THE CIRCLE IS COMPLETED BACK AT THE TWO 10" UNITS AS SHOWN AS SHOWN IN THE CONSTRUCTION SEQUENCE.

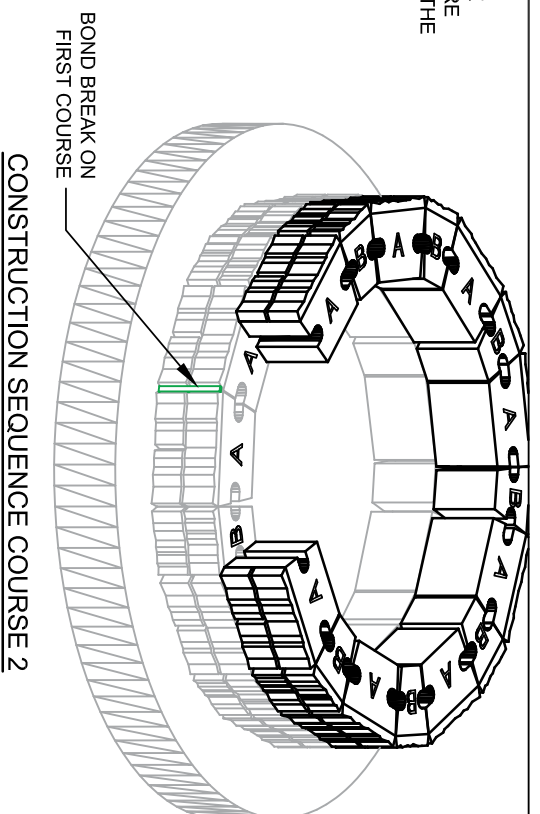
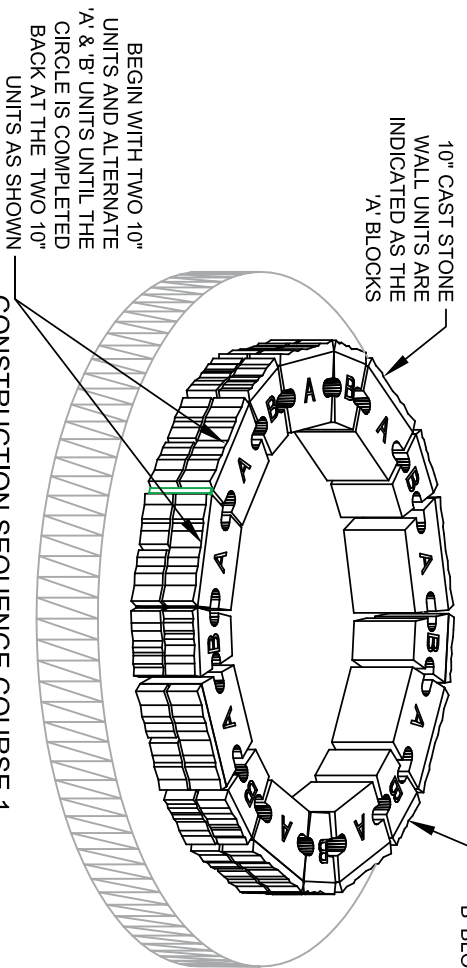

NOTE: SPARK GUARD IS NOT SHOWN FOR CLARITY

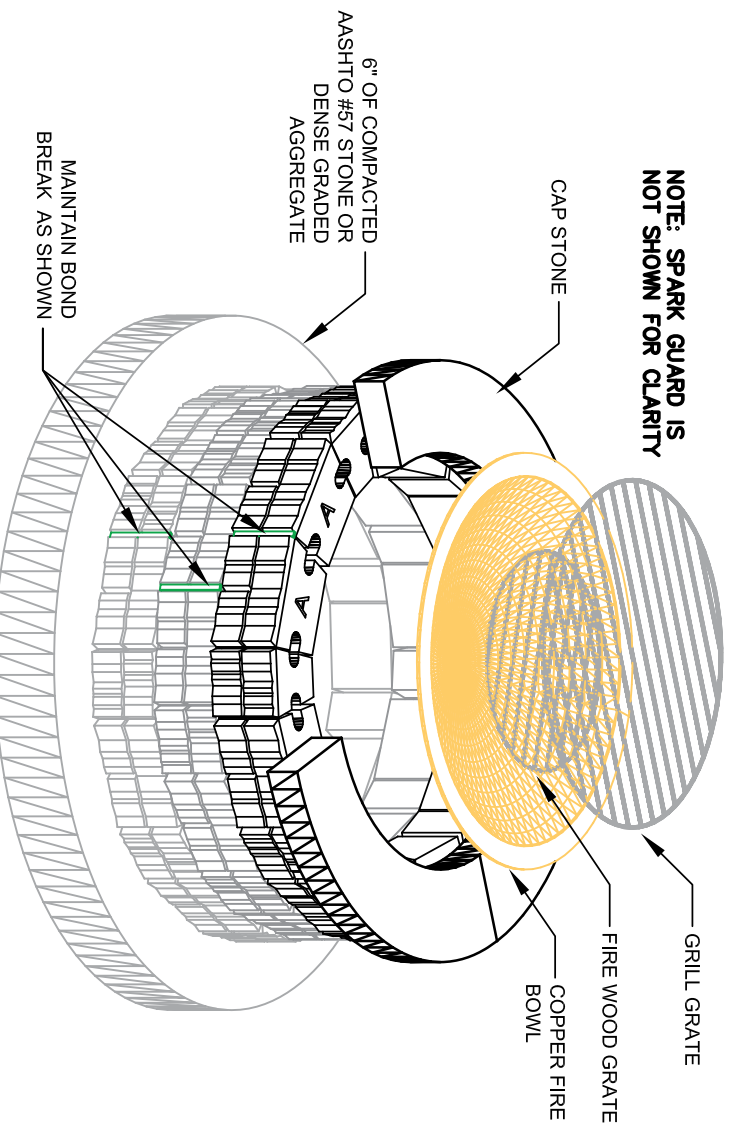
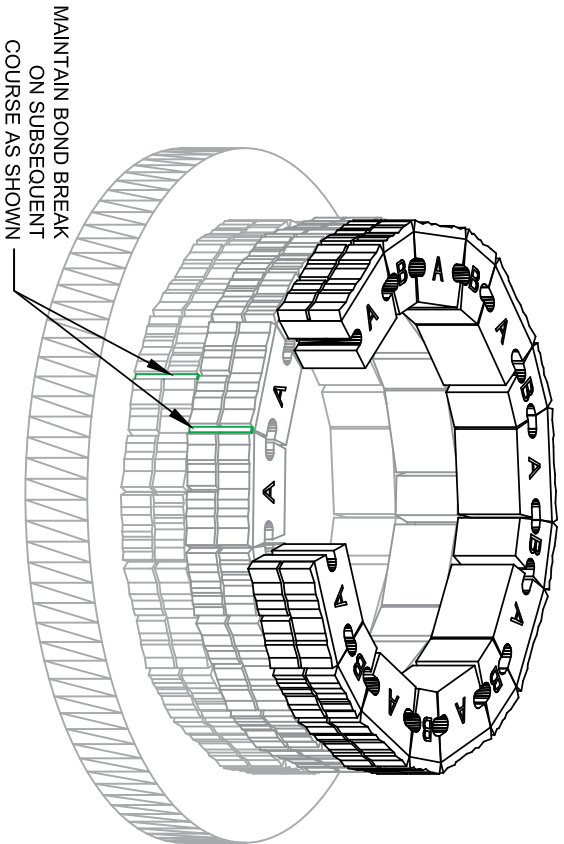

TITLE:

CAST STONE WALL FIRE PIT INSTALLATION DETAIL

SCALE:

NOT TO SCALE

GP HENRY®

201 Park Ave.
Woodbury, NJ 08096
(800)-444-3679
www.cphentry.com

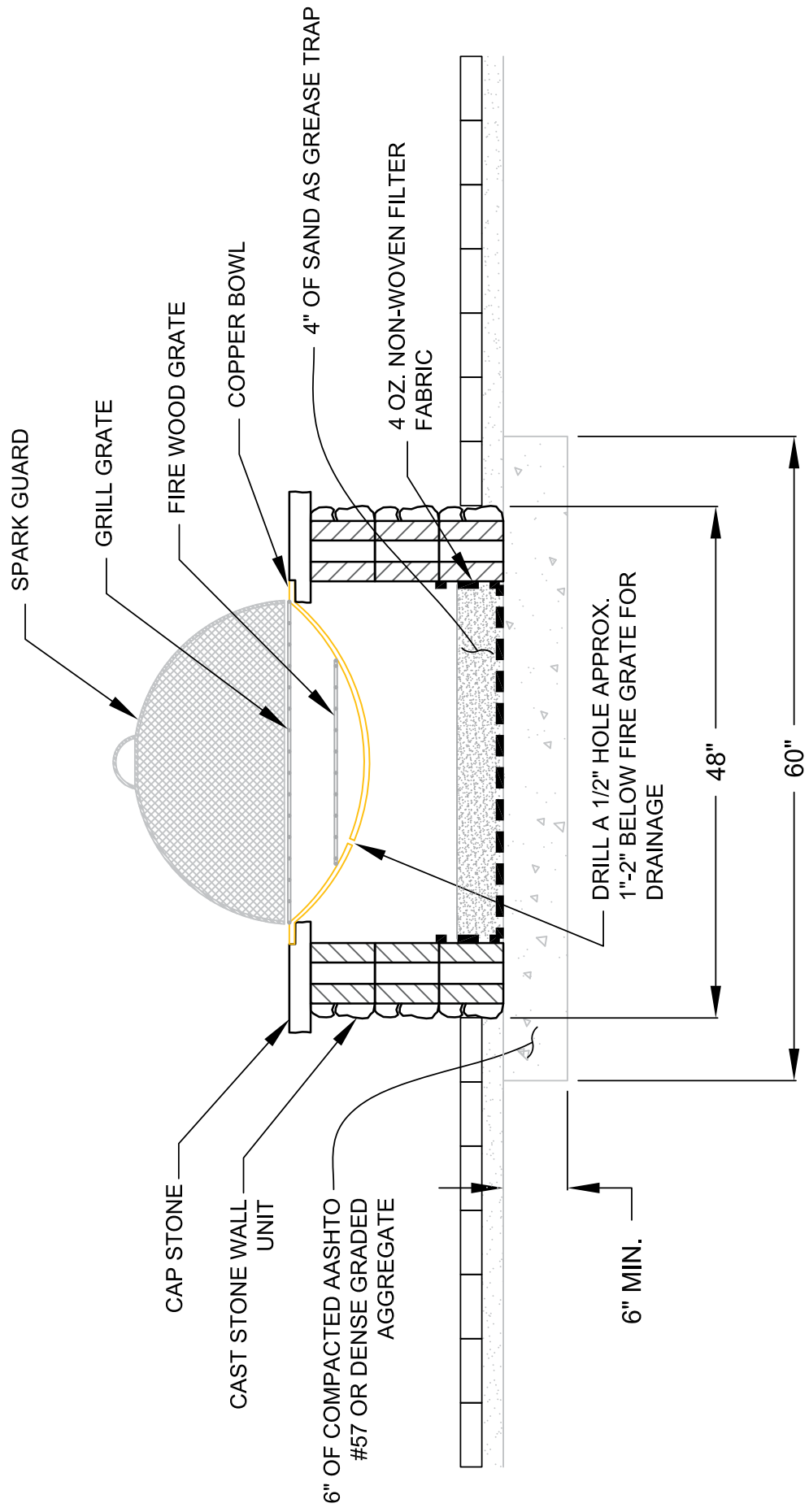

TITLE: CAST STONE WALL FIRE PIT CROSS-SECTION

SCALE: NOT TO SCALE

201 Park Ave.
 Woodbury, NJ 08096
 (800)-444-3679
 www.ephenry.com



CAST STONE WALL FACE SHELLS

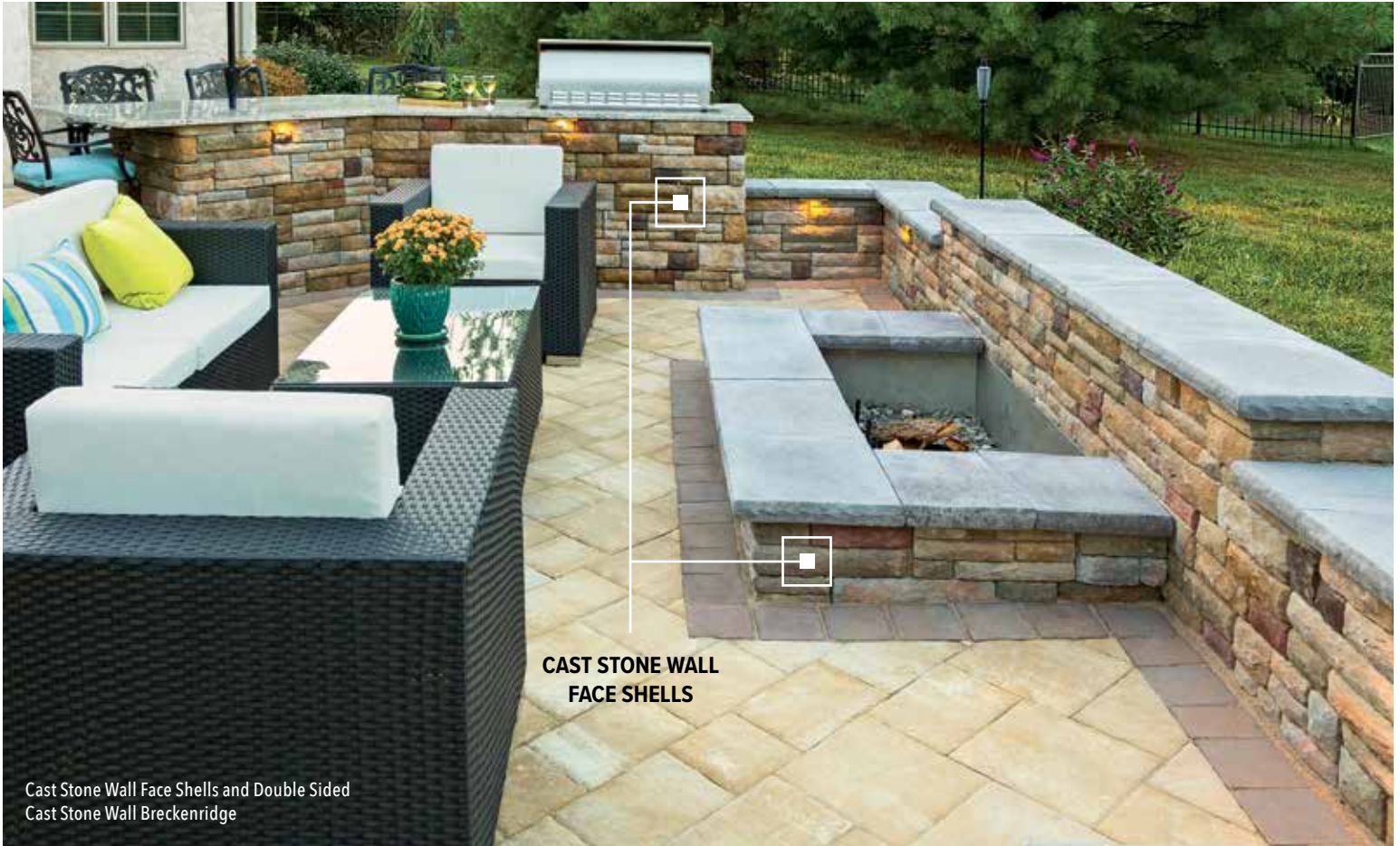

**CAST STONE WALL
FACE SHELLS**

Cast Stone Wall Face Shells and Double Sided
Cast Stone Wall Breckenridge



Adirondack, Full Face



Aspen, Random Face



Birch, Random Face



Breckenridge, Mixed Face

FACE SHELLS	STRETCHER	CORNER
SF PER CUBE	12	8 LF
PCS PER CUBE	18	-
LBS PER PIECE	6.6	-
LBS PER CUBE	119	110*

* Face Shell Stretchers and Corners available in Random and Full Face Styles



Stretcher



Corner

FREQUENTLY ASKED QUESTIONS

GENERAL

Q: Is Cast Stone Wall a wetcast or a drycast concrete product?

A: Cast Stone Wall combines wet and dry-cast technologies in one product.

Q: Will the wall faces come off of the Cast Stone Wall block?

A: Cast Stone Wall is manufactured with a patented process that creates a monolithic block. Cast Stone Wall units have been through rigorous freeze/thaw testing and Cast Stone Wall comes with a 50 year warranty.

Q: How many colors are in the Cast Stone Wall product line?

A: At the time this catalog was printed, Cast Stone Wall is available in the following multi-blend colors: Adirondack, Aspen, Birch, Breckenridge and, while supplies last, Durango.

Q: What are the face dimensions of Cast Stone Wall?

A: Both Single and Double Sided Cast Stone Wall block have faces 6”H x 16”L – 0.67 SF of wall face. Double Sided Cast Stone Wall is also available in a pallet containing both 6”H x 6”L and 6”H x 10”L units.

Q: I’ve noticed pieces of various sizes on a Cast Stone Wall. Is there a pattern to put them all together?

A: One of the key features of the Cast Stone Wall System is that many blocks contain random faces, meaning that one 6” x 16” block will have the appearance of being multiple pieces. Full Face units are also available in both Single and Double Sided Cast Stone Wall. With scores of different face styles and the ability to mix Random and Full Face cubes on any Cast Stone Wall project, the Cast Stone Wall System allows you to create stunning, natural-looking walls.



FULL FACE



RANDOM FACE



MIXED FACE

Q: Do the block have a distinct top and bottom?

A: Neither Single nor Double Sided Cast Stone Wall block have a distinct top or bottom, allowing for flexibility in design and installation.

Q: Should Cast Stone Wall be installed with a batter?

A: Both Single and Double Sided Cast Stone Wall are meant to be installed vertically with no setback.

Q: Does Cast Stone Wall use a connection system?

A: Both Single and Double Sided Cast Stone Wall are gravity systems. Use a high-strength concrete adhesive between courses of block, including the buried base course and cap. EP Henry recommends the use of Techniseal Structure Bond Adhesive.

Q: The project that I’m quoting requires quantities that are less than a full pallet. Any solution?

A: Reduced Quantity Pallets are available for both Single and Double Sided Cast Stone Wall.

Q: I’d love to cover the ugly foundation walls on my project with a veneer that looks like Cast Stone Wall. Do you have a product that I can use?

A: Cast Stone Wall Face Shells – flats and corners – are available that will perfectly match your wall.



FAQS

SINGLE SIDED CAST STONE WALL

Q: What is the maximum wall height for Single Sided Cast Stone Wall?

A: The maximum unreinforced wall height is 30" (including buried course) under ideal conditions. Beyond 30", geogrid reinforcement should be used. Maximum reinforced wall height is 8 feet (including buried course(s)). Design charts showing geogrid placement are available from EP Henry. These cannot be used in lieu of sealed engineering drawings, where required.

Q: What kind of base do I need for my Single Sided Cast Stone Wall when used in a retaining wall application?

A: As with other segmental retaining wall systems, a base of 4-6" of well compacted modified stone or # 57 clean stone is required.

Q: What should I use as a base course for my Single Sided Cast Stone Wall?

A: All retaining walls require a buried first course to secure the toe of the wall. EP Henry recommends the use of a Terrace Wall block for the buried course.

Q: Do I need to core fill my Single Sided Cast Stone Wall?

A: Core fill all units with #57 (1-1/4", 3/4" and 1/2") or #67 (3/4") clean stone. Crushed or recycled concrete is NOT suitable for this purpose.

Q: What is the smallest wall radius that can be constructed using a 16" Single Sided Cast Stone Wall block?

A: The smallest radius that can be created using a 16" long block is 22" (measured from the back of block)

Q: What cap should be used on my Single Sided Cast Stone Wall?

A: Because of Cast Stone Wall's beautiful natural stone look, our wetcast Double Sided Devonstone Caps are recommended.

Q: How do I build a 90° corner in my wall using Single Sided Cast Stone Wall?

A: Full Face and Random Face 8" x 6" x 16" rectangular units with a finished end are available for 90° corners.



Q: How do I build a pier using Single Sided Cast Stone Wall Corners?

A: Use Full Face and/or Random Face 8" x 6" x 16" corner units to build piers. The open space in the center of the finished pier will be approximately 8" x 8".

Q: Can I build steps using the Single Sided Cast Stone Wall System?

A: Attractive steps, in either straight or semi-circular designs, are easy to build with Cast Stone Wall units. The block units are used for the risers, with the caps or pavers used for the tread. Use Step Filler block in step applications where the product will not be visible.

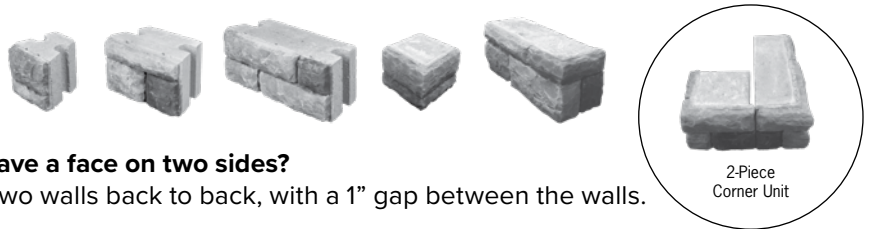

DOUBLE SIDED CAST STONE WALL

Q: Does the Double Sided Cast Stone Wall block have a face on two sides?

A: No. The system is designed for you to construct two walls back to back, with a 1" gap between the walls.

Q: Why is there a 1" gap between the walls?

A: The 1" gap facilitates any curves that might be required in the wall. Wall termination block will only work properly if there is a 1" gap between the walls.

Q: How wide will a finished Double Sided Cast Stone Wall be?

A: Properly constructed, a finished Double Sided Cast Stone Wall will be approximately 14" Deep (including the 1" gap)

Q: Does Double Sided Cast Stone Wall come in Full Face configurations?

A: Yes, Double Sided Cast Stone Wall is available in both Random and Full Face units.

Q: What is the maximum wall height for Double Sided Cast Stone Wall?

A: Double Sided Cast Stone Wall is designed for free-standing double sided wall applications only with a maximum height of four courses (not including the footer block).

Q: Can I use Double Sided Cast Stone Wall as a retaining wall?

A: Double Sided Cast Stone Wall is not meant to be used as a garden wall, landscape wall or retaining wall.

Q: What are the 6” and 10” long units for?

A: Use the pallets containing the 6” and 10” long block whenever tight curves or serpentine walls are needed. Alternating 6”L and 10”L units allows you to construct a wall with a 17” inside radius. The 6”/10” pallet of Double Sided Cast Stone Wall contains 9 SF, enough to cover a 2 foot high double sided wall 4½ feet long.

Q: Why are the pallets with the 6” and 10” long units more expensive than the pallets with all 16” stretchers?

A: Two block vs. one block are required for every 16” of wall length. More labor and machine time are required to manufacture two blocks.

Q: What should I use as a base course for my Double Sided Cast Stone Wall?

A: Use the Cast Stone Wall Footer Block as a foundation for Double Sided Cast Stone Wall. Blocks are 11-5/8”W x 4”H x 15-5/8” L. Footer Block is designed to be installed with the 15-5/8” dimension across the depth of the wall, supporting both sides. Estimate 1 block for every 1’ of wall.

Q: How do Double Sided Cast Stone Wall wall terminations work?

A: Double Sided Cast Stone Wall™ terminations are sold in pairs of two different sized block — 6”W x 6”H x 16”L and 8”W x 6”H x 8”L. Place the long and short corner units back-to-back as opposing pairs to create the end of the wall. Alternate the position of the corner units on each successive course to maintain a running bond pattern. Use the Double Sided Cast Stone Wall Corners to make 90° turns in your wall, where required.



1st Course

Q: What cap should be used on my Double Sided Cast Stone Wall?

A: Because of Double Sided Cast Stone Wall’s beautiful natural stone look, our 16” Double Sided Devonstone Caps are recommended to cap the wall. These caps are available in a trapezoid shaped unit and an end cap with 90° corner.

CAST STONE WALL FIRE PITS

Q: How do I build a Fire Pit with Cast Stone Wall?

A: EP Henry offers a Cast Stone Wall Fire Pit Kit which includes wall block, wall caps, copper bowl, 2 grates, screen and fire poker. Twenty seven 10”L block (9 per course) and twenty-four 6”L block (8 per course) are used to build the fire pit. There will be three extra 6” blocks when the Fire Pit is fully constructed. The Cast Stone Wall Fire Pit Kit is available in all stock Cast Stone Wall colors.



It’s best to start construction by drawing a 34” diameter circle where the fire pit will go. A nail in the center with a 17” string and marking tool works great. Begin each ring by placing two 10” block side by side and then alternating 6” and 10” units to complete the circle. Build subsequent rings in the same fashion, making sure to stagger the bond between courses to prevent vertical seams.

Q: What are the finished dimensions of the Cast Stone Wall Fire Pit?

A: The finished Cast Stone Wall Fire Pit will be 18” (3 courses) with a 47” outside diameter and 34” inside diameter.

CAST STONE WALL™ TECHNICAL INSTALLATION GUIDE



EP HENRY®

800.44.HENRY

ephenry.com

EPHenryUSA

